

INSCAPE BENCH

State of South Carolina

Contract #4400005978

September 2013 Price List

Inscape Corporation
221 Lister Avenue
Falconer NY, 14733
Telephone: 905 953 5186
Fax: 877 870 0034
www.inscapesolutions.com

Table of Contents

Inscape Bench	F		
Inscape Bench Architecture		Inscape Bench Accessories	
Spine and Tiles Product Map	F-3	Bench Accessories Product Map	F-42
Spine, Trim and Connectors, Tiles General Information	F-4	Accessories General Information	F-43
Spine	F-6	Spine Accessories	F-44
Stack-on for Spine	F-7	Add on Glaze	F-46
Double Glaze Stack on	F-8	Open “H” Leg Accessories	F-47
Trim and Connectors	F-9		
Full Height Tile	F-10	Inscape Bench Storage	
Partial Height Tile	F-11	Bench Storage Product Map	F-50
Partial Height Multi Access and Communication Tile	F-14	Storage General Information	F-51
Stack on Tiles (10.125”)	F-15	Lateral Storage for Inscape Bench	F-55
		Pedestal Storage for Inscape Bench	F-56
		Twin Bin	F-58
Inscape Bench Technology			
Technology Product Map	F-17		
Technology General Information	F-18		
Electrical	F-20		
Data Components	F-21		
Inscape Bench Worksurfaces			
Worksurfaces Product Map	F-23		
Worksurfaces General Information	F-24		
Rectangular Bench Worksurface	F-26		
Worksurface for Electrical Access	F-30		
Bench Electrical Access Worksurface	F-31		
Height Adjustable Worksurface	F-35		
Worksurface Supports	F-37		
End Supports	F-39		

Inscape Bench Spine

Inscape Bench spines are constructed of 16 gauge tubular steel uprights with welded 18 gauge steel crossrails. This strong yet lightweight construction provides ease of movement and reconfiguration.

The simplicity of the spine structure provides an intelligent solution to cable management. The absence of baseplates, apertures and corner posts eliminate barriers that restrict the routing of cables. Cabling may be routed both vertically and horizontally through the panel. Cables are laid into cable managers that easily install between panel crossrails throughout the framework. Cable managers safely cradle and segregate cables. An aperture free system means installation and reconfiguration costs are kept to a minimum. Reconfiguration is easy and economical. Cabling simply eases out of the cable managers and is laid back in at the desired point, eliminating the costly need to cut and re-terminate cables for every reconfiguration. *See Inscape Bench Application Guide for quantity of cables achievable in the various spines.

Spines do not include the electrical cover kit but may house power which is to be accessed alternate locations with a “cut out” tile. The spine comes with one wire manager. Electrical and data components must be specified separately.

Spine glides provide 1.5” height adjustment allowing air to circulate. Spines are available in 6” increments in widths ranging from 30” wide to 60” wide.

A **Mid Spine Support Leg** must be specified when the Partial Height Spine or the Filing Spine are specified. This leg is a support between two units

The **Stack on Frame** consists of a 6.75”, 10.125”, 13.5”, 20.25” and 27” frame which may be installed on any Inscape Bench spine of the same width or combination of two frames as outlined in the Inscape Bench Application Guide only. The Stack on frame is load bearing to one storage unit above 64” height and may be stacked up to 91”h. Tiles and trim is specified separately. Stack-on frames are frame thickness specific and should be specified accordingly.

Double Glazed Stack-on kit is a stack-on with a double glazed insert. The 30” to 60” wide Double Glazed Stack-on is a fully welded frame stack on. Double Glazed Stacks which are 54” and wider are kitted and are installed on site. The Double Glazed Stack on is not load bearing and no stacks can be stacked on top of the Double Glaze. Finishes are available in Clear or Frosted Acrylic to match Double Glazed tile.

Trim & Connectors

All **top caps, end of line trim, and connectors** must be specified independently from the frame.

Inline connectors are specified to join two units together which are in alignment. These connectors are specified based as INLINE-2 which will connect any of the Inscape Bench spines as well as the stack-ons. Be sure to specify inline connectors for the Stack-ons and Double Glaze Kits separately.

Top Caps are specified separately. The Top Cap includes clips to mount on spine or Stack-on in addition to the option of spanning two frames as outlined in the Inscape Bench Application Guide.

End Trim is kit structured to include all brackets, bolts and finished trim; Flat profile. Trim is manufactured from aluminum and always aligns straight and true at end of the Filing spine. All painted aluminum vertical trim and top trim are easily removed to facilitate lay in of cables.

Stack-on End Trim is used when a higher Stack-on requires vertical end trim at a connection. Hi-Lo trim may be used in this application for Flat profile trim because there is no ‘scribing’ that is required for this profile.

Tiles

Tiles are available as fabric, painted, tackable, veneer, Nuform, Double Glazed, Paper Management and whiteboard. 13.5”h tiles are interchangeable between Inscape System and Inscape Bench. Tile heights vary and must always align with the spine they are to be installed on. I.e. 23.6”h tiles = Full Height Spine, 10.125”h tiles = Stack on, 13.5”h tiles = Partial Height and Storage Spine. Tile clips support spine tiles and top trim. The clips are made of Delrin which is a resin similar to nylon in strength but has more rigidity and superior memory. These characteristics allow the Inscape Bench clips to retain their original shape without permanently deforming under continual pressure. This ensures tiles and trim will snap into place with a solid “click” time after time.

Fabric and Painted tiles are available 23.6”, 10.125” and 13.5” high and are constructed of 24 gauge galvanized steel. Powder-coated and fabric-covered steel tiles have a flame spread rating of less than 200 when tested according to ASTM-E84. Fabric-covered tiles are available in standard fabrics or COM. COM fabrics are subject to approval. White or extremely light colored COM fabrics will incur an upcharge of 25% to the tile pricing with which the fabric is being applied.

This is due to special handling of the fabric and tiles, in addition to painting of the tiles. Painted tiles are available in the colors shown in our Color Guide and are available in the following styles: plain steel, embossed, perforated, and steel screen. Fabric on tiles is applied in a railroad orientation.

Tackable tiles are constructed from 24 gauge cold rolled steel with a paint finish on all surfaces to prevent corrosion. The same general rules from the fabric tile section apply to the Tackable tiles. Fabric on tiles is applied in a railroad orientation. NRC 0.57, STC 9. **Tackable Acoustical tiles are available through Standard Specials with and NRC .73 and an STC of 12.

Nuform Tiles consist of gray melamine-backed MDF substrate 0.375" thick, with vacuum-formed Nuform foil over the front's surface and sides. The back-side of the tile also has routing features that accept zinc die-cast tile clips. All Nuform tiles incorporate a stiffener on the rear of the tile to ensure straightness and rigidity. This stiffener limits where the tile may be placed on the Inscape Bench spine. Nuform tiles cannot be specified in a location where a power track is installed due to interference. A sticker on the back of Nuform tiles provides UL flame / smoke-rating information. Woodgrain pattern is vertical. Due to limitations in the foil size, 48" and wider tiles are not available in F06 Walnut.

Composite Veneer tiles are constructed utilizing 45 lbs. density particle board with an engineered balanced backer for structural integrity. Veneer thickness is 0.025". The backside of the tile has routing features that accept zinc die-cast tile clips. All Composite Veneer tiles incorporate a stiffener on the rear of the tile to ensure straightness and rigidity. This stiffener bar limits where the tile may be placed. Composite Veneer tiles cannot be specified in a location where a power track is installed due to interference on an Inscape Bench spine. Woodgrain pattern is vertical.

Whiteboard Tiles are available in heights of 13.5". Tiles are constructed from 24 gauge cold rolled steel with a white paint finish that has been specifically formulated for dry erase markers. Whiteboards are seamless and fit same locations as standard painted tiles. *Note: Inscape whiteboards are specifically designed for use with DRY-ERASE markers only. WHITEBOARDS ARE NOT INTENDED FOR USE WITH PERMANENT MARKERS. Inscape advises the use of Sanford Expo Dry Erase markers*

with whiteboards. For a thorough cleaning, use Sanford Expo spray cleaner.

Paper Management tiles support horizontal paper management accessories. Organizers may be positioned at any point along the width of the tile. Three slats structured into the tile allow for three different height options for the accessories to be installed. Accessories may be found under Horizontal Accessories under the "Storage and Accessories" section. Maximum load capacity is 75lbs. When specifying paper management tiles which will be supporting a monitor arm, a Paper Management Reinforcing kit is required for additional structure. The 54" and 60" w tiles are pre-structured with these kits.

Perforated and Embossed tiles are constructed of 24 gauge galvanized steel, the **Steel Screen tiles** are constructed from 24 gauge cold rolled steel. Tiles may be painted in any of Inscape's standard colors or color matches.

Communication tiles provide power OR data access. The 30" wide includes one cut out while all wider tile widths include two cut outs. Bezels in tile may be specified in black, white (close match to P168 – Glacier White) and gray (close match to P326 – Moonlight) as well with the data or electrical components. Bezels are flush with tile, NOT recessed.

Multi Access tiles provide electrical AND data access. Cut outs align with power track and proper tiles must be specified in specific areas if stated. Data and Electrical components may be specified from the Technology section. Bezels in tile may be specified in black, white (close match to P168 – Glacier White) and gray (close match to P326 – Moonlight) as well with the data or electrical components. Bezels are flush with tile, NOT recessed.

Double Glazed tiles are available in 13.5" high and may be installed on frames 24" to 48" wide in place of a tile. Double Glazed tiles feature a double pane of frosted acrylic or clear acrylic framed by vertical and horizontal trim. Double Glazed tiles may be installed one on top of another. If wider than 60" of glaze is desired; **Stack on Double Glazed** kits may be specified.

Spine

- 2 3/4" thick spine when clad with tiles
- Power Track Kit (Upper Deck) only - no electrical clips included
- includes one cable hook

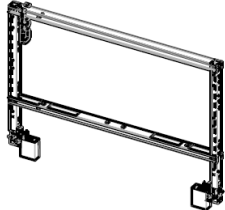
Description	Product No.	Height	Width	Thickness	List Price
Full Height Benching Spine					
	INBFHF2730	27	30	2.75	\$157
	INBFHF2736	27	36	2.75	\$161
	INBFHF2742	27	42	2.75	\$164
	INBFHF2748	27	48	2.75	\$167
	INBFHF2754	27	54	2.75	\$170
	INBFHF2760	27	60	2.75	\$196

Partial Height Benching Spine

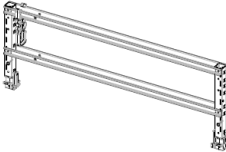
	INBPHF13.530	13.5	30	2.75	\$128
	INBPHF13.536	13.5	36	2.75	\$132
	INBPHF13.542	13.5	42	2.75	\$135
	INBPHF13.548	13.5	48	2.75	\$138
	INBPHF13.554	13.5	54	2.75	\$142
	INBPHF13.560	13.5	60	2.75	\$167

Storage Anchored Benching Spine

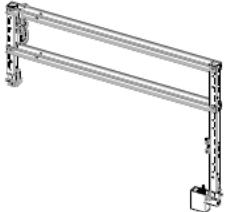
	INBFF30	13.5	30	2.75	\$140
	INBFF36	13.5	36	2.75	\$143
	INBFF42	13.5	42	2.75	\$147
	INBFF48	13.5	48	2.75	\$150
	INBFF54	13.5	54	2.75	\$153
	INBFF60	13.5	60	2.75	\$179

Mid Spine Support Leg





INBMSL10	10				\$188
-----------------	----	--	--	--	--------------

- must be specified at all situations where two frames join (except Full Height Benching spine)

Stack-on for Spine

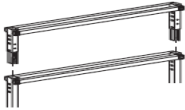
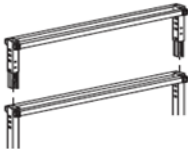
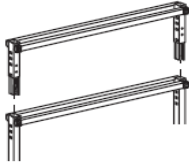
- 2 3/4" thick
- no Twin Bin placement on the 13.5"h Stack-on
- 20.25"h requires an additional crossrail (separately) if Twin Bin or 13.5"h tile being specified
- Fully welded stack on kits easily installed and removed to adjust panel height
- Load bearing – only one overhead unit on frame higher than 64"h only
- Stack on frames may span multiple frames *See Application Guide for spanning guidelines

Description	Product No.	Height	Width	List Price
6.75"h Single Stack-on				
	INSF030-2F	30	6.75	\$124
	INSF036-2F	36	6.75	\$127
	INSF042-2F	42	6.75	\$130
	INSF048-2F	48	6.75	\$134
	INSF054-2F	54	6.75	\$135
	INSF060-2F	60	6.75	\$138
10.125"h Single Stack-on				
	INSF1030-2F	30	10.125	\$126
	INSF1036-2F	36	10.125	\$129
	INSF1042-2F	42	10.125	\$132
	INSF1048-2F	48	10.125	\$137
	INSF1054-2F	54	10.125	\$138
	INSF1060-2F	60	10.125	\$140
13.5"h Single Stack-on				
	INSF130-2F	30	13.5	\$128
	INSF136-2F	36	13.5	\$131
	INSF142-2F	42	13.5	\$134
	INSF148-2F	48	13.5	\$139
	INSF154-2F	54	13.5	\$140
	INSF160-2F	60	13.5	\$141
20.25"h Single Stack-on				
	INSF2030D-2F	30	20.25	\$137
	INSF2036D-2F	36	20.25	\$140
	INSF2042D-2F	42	20.25	\$143
	INSF2048D-2F	48	20.25	\$146
	INSF2054D-2F	54	20.25	\$147
	INSF2060D-2F	60	20.25	\$149
27"h Single Stack-on				
	INSF230-2F	30	27	\$149
	INSF236-2F	36	27	\$152
	INSF242-2F	42	27	\$154
	INSF248-2F	48	27	\$158
	INSF254-2F	54	27	\$159
	INSF260-2F	60	27	\$160



Double Glaze Stack on

- Stack on Double Glaze is non-load bearing
- Stack on Double Glaze may span two frames *See Application Guide for spanning guidelines
- 30" to 48" wide kits consist of welded frames
- 54" to 96" wide kits are kitted and must be assembled onsite
- Clear and Frosted Acrylic options available
- May be located in the top location only
- no Twin Bin placement on the 13.5"h Stack-on
- 20.25"h requires an additional crossrail (separately) if Twin Bin or 13.5"h tile being specified

Description	Product No.	Height	Width	Thickness	Clear Acrylic	Frosted Acrylic
	INSTGL30-2F	13.5	30	2.75	\$404	\$474
	INSTGL36-2F	13.5	30	2.75	\$462	\$542
	INSTGL42-2F	13.5	42	2.75	\$501	\$588
	INSTGL48-2F	13.5	48	2.75	\$554	\$650
	INSTGL54-2F	13.5	54	2.75	\$607	\$701
	INSTGL60-2F	13.5	60	2.75	\$669	\$774
	INSTGL72-2F	13.5	72	2.75	\$734	\$860
	INSTGL84-2F	13.5	84	2.75	\$778	\$911
	INSTGL96-2F	13.5	96	2.75	\$822	\$963

Trim and Connectors

- Inline Connectors are required to be specified when frames are connected inline
- Specified independently of frame and may span two frames. *See Inscape System Application Guide
- All mounting hardware is included for corresponding frame thickness
- Veneer trim is up to a maximum length of 48"
- Top Trim up to 60"w requires two additional Jesters to be specified if spanning multiple frames (i.e. a 60"w top trim installed on 2_30" frames)
- Veneer trim available in specific height only (not 10.125"height)
- Stack-on End Trim is specified when stack frames are specified
- End of line trim is specified when storage is being specified and there is visibility to the end of the frame (all other end conditions include finished appearance with no end trim needed)

Description	Product No.	Height	Width	Thickness	List Price
Inline Connectors					
24"H - 51"H Frame					
	INLINE-2				\$0
Top Trim					
	INTC30-2F		30	2.75	\$46
	INTC36-2F		36	2.75	\$49
	INTC42-2F		42	2.75	\$53
	INTC48-2F		48	2.75	\$55
	INTC54-2F		54	2.75	\$68
	INTC60-2F		60	2.75	\$73
	INTC72-2F		72	2.75	\$89
	INTC84-2F		84	2.75	\$105
INTC96-2F		96	2.75	\$111	
Stack-on End Trim					
	INETHL6.75-2F	6.75		2.75	\$19
	INBET10.125-2F	10.125		2.75	\$25
	INETHL13.5-2F	13.5		2.75	\$31
	INETHL20.25-2F	20.25		2.75	\$38
	INETHL27-2F	27		2.75	\$59
End Trim					
Storage End	INBETEND27-2F	27		2.75	\$40

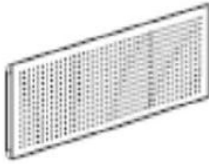
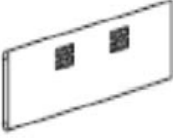
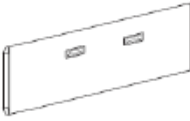

Full Height Tile

-23.6" h tiles may only be mounted on Full Height bench spine

Description	Product No.	Width	Height	List Price
23.6" h Painted Tile				
	INB23.6P30	30	23.625	\$72
	INB23.6P36	36	23.625	\$85
	INB23.6P42	42	23.625	\$91
	INB23.6P48	48	23.625	\$104
	INB23.6P54	54	23.625	\$112
	INB23.6P60	60	23.625	\$129
23.6" h Perforated Tile				
	INB23.6PF30	30	23.625	\$81
	INB23.6PF36	36	23.625	\$96
	INB23.6PF42	42	23.625	\$104
	INB23.6PF48	48	23.625	\$122
	INB23.6PF54	54	23.625	\$136
	INB23.6PF60	60	23.625	\$149
23.6" h Painted Multi Access Tile				
	INB23.6MAP30	30	23.625	\$137
	INB23.6MAP36	36	23.625	\$140
	INB23.6MAP42	42	23.625	\$148
	INB23.6MAP48	48	23.625	\$156
	INB23.6MAP54	54	23.625	\$174
	INB23.6MAP60	60	23.625	\$178
23.6" h Painted Communication Tile				
	INB23.6CTP30	30	23.625	\$137
	INB23.6CTP36	36	23.625	\$140
	INB23.6CTP42	42	23.625	\$148
	INB23.6CTP48	48	23.625	\$156
	INB23.6CTP54	54	23.625	\$174
	INB23.6CTP60	60	23.625	\$178

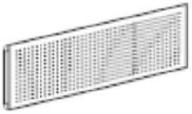
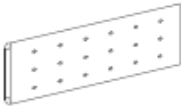

Partial Height Tile

-13.5" h tile may be specified with Partial Height Spine or Filing Spine
 - tiles are standard 13.5" h Inscape System

Description	Product No.	Height	Width	List Price
13.5" h Painted Tile				
Half Height Benching Tile	IN13.5P30	13.5	30	\$53
	IN13.5P36	13.5	36	\$54
	IN13.5P42	13.5	42	\$56
	IN13.5P48	13.5	48	\$58
	IN13.5P54	13.5	54	\$60
	IN13.5P60	13.5	60	\$63
13.5" h Perforated Tile				
Half Height Benching Tile	IN13.5PF30	13.5	30	\$63
	IN13.5PF36	13.5	36	\$64
	IN13.5PF42	13.5	42	\$65
	IN13.5PF48	13.5	48	\$68
	IN13.5PF54	13.5	54	\$69
	IN13.5PF60	13.5	60	\$71
13.5" h Embossed Tile				
Half Height Benching Tile	IN13.5EM30	13.5	30	\$63
	IN13.5EM36	13.5	36	\$64
	IN13.5EM42	13.5	42	\$65
	IN13.5EM48	13.5	48	\$68
	IN13.5EM54	13.5	54	\$69
	IN13.5EM60	13.5	60	\$71
13.5" h Screen Tile				
Half Height Benching Tile	IN13.5ST30	13.5	30	\$66
	IN13.5ST36	13.5	36	\$71
	IN13.5ST42	13.5	42	\$78
	IN13.5ST48	13.5	48	\$83
	IN13.5ST54	13.5	54	\$93
	IN13.5ST60	13.5	60	\$98

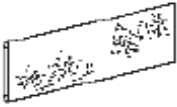

Partial Height Tile

-13.5" h tile may be specified with Partial Height Spine or Filing Spine
 - tiles are standard 13.5" h Inscape System

Description	Product No.	Height	Width	Grade 1/ COM	Grade 2	Grade 3	Grade 5	Grade 7
13.5" h Fabric Tile								
	IN13.5F30	13.5	30	\$81	\$84	\$88	\$99	\$128
	IN13.5F36	13.5	36	\$84	\$91	\$102	\$117	\$154
	IN13.5F42	13.5	42	\$88	\$94	\$107	\$123	\$163
	IN13.5F48	13.5	48	\$91	\$100	\$110	\$126	\$167
	IN13.5F54	13.5	54	\$93	\$103	\$113	\$132	\$176
	IN13.5F60	13.5	60	\$98	\$108	\$118	\$137	\$181
	IN13.5F66	13.5	66	\$183	\$193	\$203	\$222	\$266
	IN13.5F72	13.5	72	\$184	\$192	\$196	\$208	\$259
	IN13.5F78	13.5	78	\$185	\$194	\$198	\$211	\$266
	IN13.5F84	13.5	84	\$195	\$204	\$208	\$221	\$276
	IN13.5F90	13.5	90	\$196	\$206	\$210	\$225	\$282
	IN13.5F96	13.5	96	\$198	\$210	\$213	\$230	\$288
13.5" h Tackable Tile								
	IN13.5TK30	13.5	30	\$119	\$121	\$126	\$139	\$178
	IN13.5TK36	13.5	36	\$122	\$129	\$137	\$154	\$202
	IN13.5TK42	13.5	42	\$126	\$134	\$142	\$159	\$209
	IN13.5TK48	13.5	48	\$143	\$151	\$159	\$179	\$231
13.5" h Nuform Tile								
	IN13.5NF30	13.5	30	\$203				
	IN13.5NF36	13.5	36	\$211				
	IN13.5NF42	13.5	42	\$221				
	IN13.5NF48	13.5	48	\$228				
13.5" h Veneer Tile								
	IN13.5WV30	13.5	30	\$249				
	IN13.5WV36	13.5	36	\$278				
	IN13.5WV42	13.5	42	\$306				
	IN13.5WV48	13.5	48	\$333				



Partial Height Tile

-13.5" h tile may be specified with Partial Height Spine or Filing Spine
 - tiles are standard 13.5" h Inscape System

Description	Product No.	Height	Width	List Price
13.5" h Whiteboard Tile				
	IN13.5WB30	13.5	30	\$79
	IN13.5WB36	13.5	36	\$81
	IN13.5WB42	13.5	42	\$83
	IN13.5WB48	13.5	48	\$86
	IN13.5WB54	13.5	54	\$96
	IN13.5WB60	13.5	60	\$101
	IN13.5WB66	13.5	66	\$176
	IN13.5WB72	13.5	72	\$181
	IN13.5WB78	13.5	78	\$187
	IN13.5WB84	13.5	84	\$192
IN13.5WB90	13.5	90	\$197	
IN13.5WB96	13.5	96	\$202	
6.75" h Paper Management Tile				
	IN6.75PM30-2F	6.75	30	\$130
	IN6.75PM36-2F	6.75	36	\$134
	IN6.75PM42-2F	6.75	42	\$149
	IN6.75PM48-2F	6.75	48	\$162
	IN6.75PM54-2F	6.75	54	\$176
	IN6.75PM60-2F	6.75	60	\$191
	IN6.75PM66-2F	6.75	66	\$253
	IN6.75PM72-2F	6.75	72	\$263
	IN6.75PM78-2F	6.75	78	\$273
	IN6.75PM84-2F	6.75	84	\$311
IN6.75PM90-2F	6.75	90	\$321	
IN6.75PM96-2F	6.75	96	\$331	



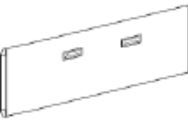
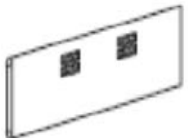

Partial Height Multi Access and Communication Tile

-13.5"h tile may be specified with Partial Height Spine or Filing Spine
 - tiles are standard 13.5"h Inscape System

Description	Product No.	Height	Width	Grade 1/ COM	Grade 2	Grade 3	Grade 5	Grade7
13.5"h Fabric Multi Access Tile								
	IN13.5MAF30-UD	13.5	30	\$90	\$93	\$97	\$110	\$149
	IN13.5MAF36-UD	13.5	36	\$100	\$104	\$110	\$129	\$175
	IN13.5MAF42-UD	13.5	42	\$103	\$106	\$116	\$131	\$178
	IN13.5MAF48-UD	13.5	48	\$107	\$114	\$124	\$141	\$190
	IN13.5MAF54-UD	13.5	54	\$108	\$116	\$127	\$145	\$195
	IN13.5MAF60-UD	13.5	60	\$117	\$118	\$127	\$147	\$199
13.5"h Fabric Communication Tile								
	IN13.5CTF30-UD	13.5	30	\$90	\$93	\$97	\$110	\$149
	IN13.5CTF36-UD	13.5	36	\$100	\$104	\$110	\$129	\$175
	IN13.5CTF42-UD	13.5	42	\$103	\$106	\$116	\$131	\$178
	IN13.5CTF48-UD	13.5	48	\$107	\$114	\$124	\$141	\$190
	IN13.5CTF54-UD	13.5	54	\$108	\$116	\$127	\$145	\$195
	IN13.5CTF60-UD	13.5	60	\$117	\$118	\$127	\$147	\$199
13.5"h Painted Multi Access Tile								
	IN13.5MAP30-UD	13.5	30	\$78				
	IN13.5MAP36-UD	13.5	36	\$83				
	IN13.5MAP42-UD	13.5	42	\$85				
	IN13.5MAP48-UD	13.5	48	\$90				
	IN13.5MAP54-UD	13.5	54	\$91				
	IN13.5MAP60-UD	13.5	60	\$93				
13.5"h Painted Communication Tile								
	IN13.5CTP30-UD	13.5	30	\$78				
	IN13.5CTP36-UD	13.5	36	\$83				
	IN13.5CTP42-UD	13.5	42	\$85				
	IN13.5CTP48-UD	13.5	48	\$90				
	IN13.5CTP54-UD	13.5	54	\$91				
	IN13.5CTP60-UD	13.5	60	\$93				

Stack on Tiles (10.125")

- tiles may only be installed on 10.125" stack on

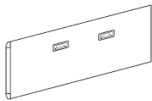
Description	Product No.	Height	Width	Grade 1/COM	Grade 2	Grade 3	Grade 5	Grade 7
10.125" Stack-on Painted Tile								
	IN10.125F30	10.125	30	\$81	\$84	\$88	\$99	\$128
	IN10.125F36	10.125	36	\$84	\$91	\$102	\$117	\$154
	IN10.125F42	10.125	42	\$88	\$94	\$107	\$123	\$163
	IN10.125F48	10.125	48	\$91	\$100	\$110	\$126	\$167
	IN10.125F54	10.125	54	\$93	\$103	\$113	\$132	\$176
	IN10.125F60	10.125	60	\$98	\$108	\$118	\$137	\$181
10.125" Stack-on Fabric Multi-Access Tile								
	IN10.12MAF30-UD	10.125	30	\$90	\$93	\$97	\$110	\$149
	IN10.12MAF36-UD	10.125	36	\$100	\$104	\$110	\$129	\$175
	IN10.12MAF42-UD	10.125	42	\$103	\$106	\$116	\$131	\$178
	IN10.12MAF48-UD	10.125	48	\$107	\$114	\$124	\$141	\$190
	IN10.12MAF54-UD	10.125	54	\$108	\$116	\$127	\$145	\$195
	IN10.12MAF60-UD	10.125	60	\$117	\$118	\$127	\$147	\$199
10.125" Stack-on Fabric Communication Tile								
	IN10.12CTF30-UD	10.125	30	\$90	\$93	\$97	\$110	\$149
	IN10.12CTF36-UD	10.125	36	\$100	\$104	\$110	\$129	\$175
	IN10.12CTF42-UD	10.125	42	\$103	\$106	\$116	\$131	\$178
	IN10.12CTF48-UD	10.125	48	\$107	\$114	\$124	\$141	\$190
	IN10.12CTF54-UD	10.125	54	\$108	\$116	\$127	\$145	\$195
	IN10.12CTF60-UD	10.125	60	\$117	\$118	\$127	\$147	\$199
10.125" Stack-on Painted Tile								
	IN10.125P30	10.125	30	\$53				
	IN10.125P36	10.125	36	\$54				
	IN10.125P42	10.125	42	\$56				
	IN10.125P48	10.125	48	\$58				
	IN10.125P54	10.125	54	\$60				
	IN10.125P60	10.125	60	\$63				
10.125" Stack-on Painted Multi-Access Tile								
	IN10.12MAP30-UD	10.125	30	\$78				
	IN10.12MAP36-UD	10.125	36	\$83				
	IN10.12MAP42-UD	10.125	42	\$85				
	IN10.12MAP48-UD	10.125	48	\$90				
	IN10.12MAP54-UD	10.125	54	\$91				
	IN10.12MAP60-UD	10.125	60	\$93				
10.125" Stack-on Painted Communication Tile								
	IN10.12CTP30-UD	30	10.125	\$78				
	IN10.12CTP36-UD	36	10.125	\$83				
	IN10.12CTP42-UD	42	10.125	\$85				
	IN10.12CTP48-UD	48	10.125	\$90				
	IN10.12CTP54-UD	54	10.125	\$91				
	IN10.12CTP60-UD	60	10.125	\$93				

INSCAPE BENCH TECHNOLOGY

Inscape Bench Technology

General Information

Inscape Bench electrical is UL and CSA approved. New York City and Chicago solutions are also available as standard offering. The electrical system features 8 wires and 4 circuits that can be configured in a 2+2 or 3+1 circuit configuration. All electrical components, with the exception of the power feed (which must be connected to the building power supply by a licensed electrician) may be installed by furniture installers, unless otherwise stated by jurisdiction of the installation.

Inscape Bench electrical components consist of the following: Floor/Wall power in-feed, power tracks, jumper cables, duplex receptacles. Power components snap into place without the need of tools and are the same components as offered in Inscape System.

Power in-feed connections can be made through a wall, column, or floor connection. Power in-feed connections consist of an 84" long liquid tight cable and a 45" flex cable connected by a 3" metal coupler and elbow joint to sit between bottom rails. The liquid tight portion of the Power in-feed must be connected to the building power supply by an electrician. If two power feeds are being specified for one cluster of stations, care must be taken not to cross connect the two feeds through jumper cables and power tracks.

Two versions of the power in-feed exist. One version is to be used with the Full Height Spine and the other is to be used with the Partial height or Storage Spine and includes a wire casing.

New York City has requirements for special power entry assemblies. A qualified electrician is required to hard-wire the **New York City In-feed** from the entry box to the power source.

The New York City feed works for side feed, end feed or ceiling feed.

The City of Chicago does not permit the use of pre-wired modular electrical systems. To simplify hardwiring of the Inscape Bench Spine, the City of **Chicago Hold Down Bracket** (INECHB) is available. Specify two INECHB for each power entry point, one for the power feed and one for the outlet. (The outlet box is NOT supplied by Inscape). INECHB's are available in packages of 6. *Boxes should be sourced through Ental Industries or J&A Sheet both local Chicago suppliers of electrical junction boxes.*

Note: Spines 30" wide will accept one double-sided outlet box. Spines 36" wide and wider will accept two boxes. INECHB's may also be specified to mount multi-user termination boxes inside the panel.

2 + 2 Circuit Configuration

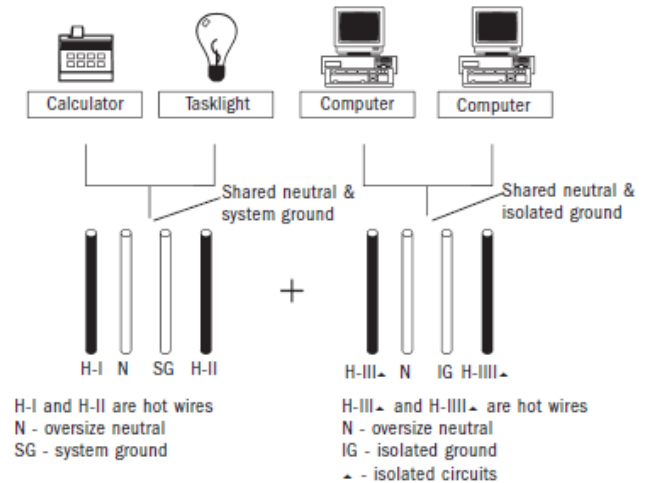

2+2 – Circuits #1 and #2 share one oversize neutral and one shared ground to provide convenience power for task lights, calculators, radios etc.

- Circuits #3 and #4 share the other oversize neutral and isolated ground to provide isolated power to computers.

3 + 1 Circuit Configuration

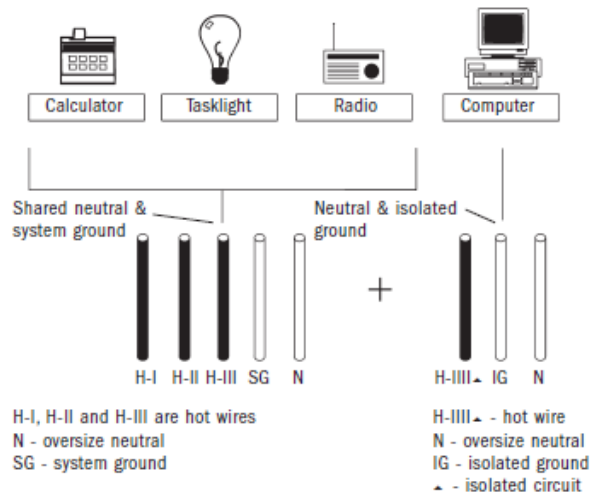

3+1 – Circuits #1, #2 and #3 share one oversize neutral and one shared ground to provide convenience power for task lights, calculators, radios etc.

- Circuit #4 uses the other oversize neutral and isolated ground to provide isolated power to computers.

Power Track Kits consist of a power track and clips to attach the power track to a crossrail. The kit allows for power tracks to be mounted in specified locations (above or below the worksurface). Jumper cables and receptacles are specified separately. The 30" wide Power Track Kit accepts one duplex per side. Power Track Kits which are 36" wide and wider accept two duplexes per side. Power Track Kits may be specified below the following; Transaction Tops, Up mount Bins, Stack on Glaze, Add on Glaze and Double Glazed Tiles. Power Track Kits MAY NOT be specified below Twin Bins or Power Poles.

Jumper Cables by-pass un-powered spines and also facilitates connections from power track to power track. Jumper cables must attach to power tracks only and cannot be attached to adjacent jumper cables or power in- feeds. Product codes indicate the width of the jumper cable which may be cross-referenced in the Inscape Bench Application Guide. Various widths of jumper cables are available to facilitate various applications and configurations. See Inscape Bench Application Guide for details.

Duplex receptacles snap into power tracks back-to-back and may be accessed through cutouts in either the electrical cover plate with standard frames or multi-access and communication tiles in all other locations and basic frames. Duplexes are interchangeable amongst the varying power track locations. Specify duplexes according to circuit configuration, 2+2 or 3+1. The IN3D3-__ duplex is specific to 2+2 wire configurations and the IN3DU3-__ duplex is specified for 3+1 wire configurations. General rule is no more than 12 receptacles per circuit per power in feed. Duplexes may be specified in black, white (close match to P168 – Glacier White) and gray (close match to P326 – Moonlight).

Data Components

The **Hinged Cover (INHRC)** snaps into the cut outs which are found in multi access and communication tiles. When data faceplates and receptacles are not required the hinged cover provides a visual and protective cover.

Fiber Optic Outlet (INCFO) is specified to be installed in a cut out in a multi access or communication tile. Available in black only.

The **Data and Communication Faceplate (INCDP)** installs in a cut out in a multi access or communication tile where plug and play access is required. The faceplate provides three "slots" where the **Category 5 (INCABRJ45)**, **Category 6 (INCABR6J45)**, and/or **Telephone Jacks (INCRJ11)** may be inserted. All "openings" need to be filled with data or phone jacks, the **Blank Data Plate Insert (INCB)** fills in any which are not being used. Data components (except the INCFO) may be specified in

black, white (close match to P168 – Glacier White) and gray (close match to P326 – Moonlight).

Clamp on Power may be clamped along edge of worksurface for plug and play access to electrical/voice/data. Unit has clear anodized aluminum case with two outlets and two voice/data cut outs. Voice and data adaptor kits are included. Voice and data jacks must be purchased separately. Clamp on power module has 72" long extension cord. This module adjusts from .75" to 1.75" for varying surface thickness.



Cable hooks support and segregate data cables and each frame ships with one cable manager. Cable hooks carry data cables to their termination voice/data point at a multi access or communication tile for plug and play access or to hanger brackets which are located behind the tile.

Wire Management clips are required when power is being routed from a Credenza Storage benching application frame to the worksurface. Where cabling is running from behind a Credenza Storage case, these wire management clips are mounted to the underside of the inside of the case and the wires are cleanly routed to the main surface. These clips come in a package of 10 and are black in color.

Wire Casing manages cables and technology from a worksurface to the floor. Casing is adjustable in length by removing or adding "links". Casing is available in gray. As standard the wire casing accommodates 28.5"h worksurface heights. The wire casing accommodates 30 Cat5 cables with electrical works at a 60% fill capacity which is recommended. Approximately 36 Cat5 cables may be accommodated in the wire casing at a 60% fill capacity without electrical works.





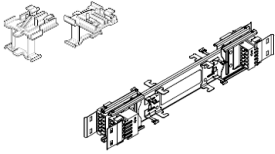
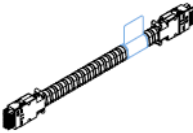
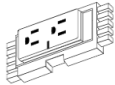



Electrical

- Power in feed to be used with partial height spine includes wire casing to enclose exposed cables
- All electrical components are standard 8 wire configuration
- Power track is required to match the width of the frame it is being installed in
- Power Track Kits may be specified below; Transaction Tops, Up mount Bins, Stack on Glaze, Add on Glaze
- Power Track Kits MAY NOT be specified below Twin Bins
- See Inscape System Application Guide for length requirements for varying panel configurations
- Jumper Cables do not connect together nor do they attach to power in feeds
- Circuit 3 receptacle requires 2+2 or 3+1 wire designation ("U" in the code signifies 3+1 wire configuration)
- White close match to 168 Glacier White, Gray close match to 326 Moonlight
- The "UD" duplexes are to be specified in conjunction with the Electrified Twin Bin (Inscape System Price List)

Description	Product No.	Width	List Price	
Power In-feed 	INEFWK-8	(use with full spine)	\$277	
	INBFWK-8	(use with partial height spine*)	\$492	
<hr/>				
New York Power In-feed				
	INEFWK-NY-8		\$492	
<hr/>				
Power Track Kit				
	INRUDKIT-30-8	30	\$141	
	INRUDKIT-36-8	36	\$153	
	INRUDKIT-42-8	42	\$167	
	INRUDKIT-48-8	48	\$182	
	INRUDKIT-54-8	54	\$193	
	INRUDKIT-60-8	60	\$208	
	For use with Electrified Twin Bin	INETPTWB-8	8	\$65
<hr/>				
Jumper Cable				
	INETC24-8	24	\$54	
	INETC25-8	25	\$54	
	INETC28-8	28	\$54	
	INETC31-8	31	\$56	
	INETC44-8	44	\$59	
	INETC53-8	53	\$65	
	INETC64-8	64	\$79	
	INETC88-8	88	\$103	
	INETC104-8	104	\$117	
	INETC122-8	122	\$146	
	INETC141-8	141	\$147	
	INETC158-8	158	\$162	
INETC182-8	182	\$184		
<hr/>				
Receptacles		Black	White	Gray
	IN2D1-8	\$19	\$25	\$25
	IN2D2-8	\$19	\$25	\$25
	IN2D3-8	\$19	\$25	\$25
	2+2 Wire Configuration IN2D3U-8	\$19	\$25	\$25
	3+1 Wire Configuration IN2D4-8	\$19	\$25	\$25

Data Components

- Data components which are face mounted have optional color of black, white or gray (default black)
- Data cannot be installed directly back to back in a benching spine
- Data components are industry standard sized AMP product
- Wire Management clips are black and attach by double sided tape which is included
- Cable Management tray is available in two lengths and painted Eco Black and includes mounting hardware

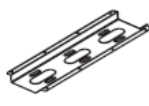
Description	Product No.	List Price		
		Black	White	Gray
Hinged Cover for Tiles with Cutouts 	INHRC	\$36	n/a	n/a
Fiber Optic Outlet *black only 	INCFO	\$102	n/a	n/a
Data Communication Plate 	INCPD	\$19	\$21	\$23
Blank Data Plate Insert 	INCB	\$10	\$13	\$13
Telephone Jack 	INCRJ11	\$21	\$24	\$24
Category 5A & 5B - RJ45 Jack 	INCABRJ45	\$34	\$37	\$37
Category 6 - RJ45 Jack 	INC6ABRJ45	\$67	\$79	\$79
Wire Management Clip 	INWMCLIP			\$21
Cable Management Tray 	INCMT18 INCMT30			\$26 \$34
Wire Manager	INFWC			\$98

INSCAPE BENCH WORKSURFACES

Worksurfaces

General Information

Depth dimension is nominal. Depths are 1" less than stated to provide a 1" gap between the worksurface and panel to facilitate wire management. Worksurfaces are specific to the worksurface support they are being installed on. Codes and dimensions are outlined in the following pages and Inscape Bench Application Guide showing which worksurface is to be specified with the End Gable, Open "H" Leg or Storage Support.

Nuform Solid and Nuform Woodgrain/Pattern Worksurfaces

The Nuform top is a thermo-formable polymer based sheet continuously bonded to a 1.25". The polymer sheet is surface coated with a scratch resistant film. Colors are homogenous throughout the film thickness. Top and edge are one continuous surface with no edge seams. The underside of the top is finished in a low pressure melamine. Nuform tops have the option of a pencil groove running across the width of the worksurface as standard and depth for conference tables. Two price options are available - Nuform Solid and Nuform Woodgrain which includes patterns.

Limitations exist with the F06, F08, F09, F10, F11, F16, F26 Nuform due to size of the foil – 48" standard and extended corners as well as 120 degree surfaces.

Edge Detail - Nuform Solid and Nuform Woodgrain

1 1/4" Straight Edge



1" Straight Edge

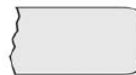

1 1/4" Tapered Edge



1" Tapered Edge



Top and edge are one continuous surface with no edge seams.

Laminate Worksurfaces

Plastic laminate is laminated to 1.25" thick particle-board. The underside of the worksurface is finished with a man-made, wood-fiber veneer backer. Worksurfaces specified with a plastic laminate finish include a 2mm edge banding in a coordinating color. Plastic laminate tops do not include a pencil groove. All worksurfaces default to 1.25" thick, Straight edge, Pencil Groove.

Edge Detail - Plastic Laminate

Straight Edge

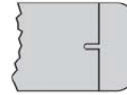

Composite Veneer Worksurfaces

Veneer thickness is 0.025". Overall thickness of top is 1.25". The stain color is impregnated throughout the veneer for color consistency. The open pore veneer is clear coated with a catalyzed lacquer utilizing a multi-step process and has a gloss value of 30° when dry. Tops are constructed utilizing 45lbs density particle board with an engineered balanced backer for structural integrity. Tops are edged in 3mm thick same species veneer and do not include a pencil groove.

Edge Detail - Composite Veneer

Straight Edge



Load capacity for freestanding and panel mounted worksurfaces is 4.5lbs per linear inch.

Grain direction on Nuform Woodgrain and Veneer worksurfaces is as denoted below.

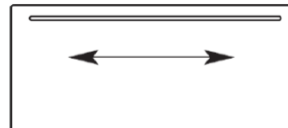

The **Worksurface Extension** is a cantilevered worksurface which is situated perpendicular to the spine. This top is available in all the worksurface finishes of the standard worksurfaces (if woodgrain is chosen, pattern will run perpendicular to the main worksurfaces). This extension CANNOT be specified adjacent to the Height Adjustable Worksurfaces.

The **Worksurface for Electrical Access** is a worksurface which provides easy access to power/data ports below the worksurface within the spine. The hinged access cover is an aluminum component which is inset into the Laminate or Veneer surfaces only. Worksurfaces are specific to the frame width in order to allow the hinged access cover to line up with the port in the spine beneath.

Adjustable Height Worksurfaces are available to be mounted on the Full Height Spine of the Inscape Bench.

Worksurfaces provide gas cylinder height adjustment ranging from 28.5" to 49.5" with a lift capacity and calibration of a recommended 25lbs (not including the worksurface). Worksurfaces structured on the height adjustable mechanism are 1" less in stated width in the price list, and are meant to be installed on center to the base allowing for a gap between adjacent surfaces to eliminate pinch points. The base mechanism of the worksurface is available in gray only. See the Inscape Bench Application Guide for application notes and restrictions.

Worksurface Support Brackets & Accessories

Cantilever Bracket is fixed. Cantilever brackets support panel mounted worksurfaces on-module.

Flush Brackets are specified when two adjoining worksurfaces need to be held flush together. These brackets (INFB) come as a pair. Maximum span of overhang when supported with a flush bracket is 18" per side. These are not required for Height Adjustable worksurfaces.

Spacers are specified when storage is being specified within the bench. The appropriate height of storage to use within the bench is 22.5" id with FLAT GLIDE (Rectangular glides will not line up below the worksurface)

Pedestal Brackets are specified when a pedestal unit is being specified. This allows for docking of the storage pieces to the benching spine. End Location Bracket is to be specified when the pedestal is at the end of a run. The Middle Location Bracket is to be specified when a pedestal is situated below the bench within the bench. *See Inscape Bench Application Guide.

Storage Docking Bracket is used when lateral or bookcase units are specified perpendicular to the spine. This bracket docks the storage and worksurface to the spine. *See Inscape Bench Application Guide.

The **Lateral Tops** are available as ¾" thick. These tops are to be specified atop the 22.5" id storage units, FLAT GLIDE only on storage. Tops are available in all standard Nuform finishes.

End Support

There are three main ways to support the Inscape Bench from an end support perspective. One option is a **Full End Gable**. This end gable unit spans the entire depth of the bench beneath the worksurfaces, which are specific to this support type. The End Gable is a fully kitted product code which includes trim, tiles, glides and structure. The trim can be painted in any standard paint color. Tiles are to be specified on the inside and outside of the end gable. Tiles on the interior consist of two separate tiles whereas the outside is one full tile. Woodgrain on the exterior tile will run vertical on the tile. The Full End Gable is only to be used with the Full Height Spine.

An alternative support is the **Open "H" Leg**. This open leg structure has the ability to span the entire depth of the bench as well as carry multiple storage/accessories components. These units may be found in the Accessories section and are specific to the "H" Leg. The Open "H" Leg is only to be used with the Partial Height Spine. *unless the Height Adjustable version is being used



Both support types have a mid-span support which matches the overall end aesthetic. These are available in 12" and 18"d. The 12" version is to be specified with 24" and 30" deep worksurfaces and the 18"d with 36"d worksurfaces. Tiles on the Full Gable version are painted only.

When the Height Adjustable Worksurface is specified, either the Full End Gable or the Open "H" Leg which is specific to the Height Adjustable may be specified.

*See Inscape Bench Application Guide for more details.

Rectangular Inscape Bench Worksurface

- 1 1/4" thick
- Worksurfaces are to be specified with any Inscape Bench spine in a middle or non-end position
- Nuform, Laminate & Veneer
- Straight & Tapered edge available on Nuform
- 84" and 96" worksurfaces require same support as two surfaces

Description	Product No.	Width	Depth	Nuform Solid /Laminate Straight Edge	Nuform Woodgrain/ Pattern	Nuform Tapered Edge	Veneer (Straight Edge ONLY)
Rectangular Worksurface							
Middle Application							
24" d 	INBW2442	42	23.675	\$289	+\$30	+\$14	\$844
	INBW2448	48	23.675	\$331	+\$35	+\$16	\$896
	INBW2454	54	23.675	\$372	+\$40	+\$20	\$946
	INBW2460	60	23.675	\$413	+\$43	+\$22	\$1,010
	INBW2472	72	23.675	\$497	+\$51	+\$25	\$1,097
	INBW2484	84	23.675	\$582	+\$60	+\$28	\$1,196
	INBW2496	96	23.675	\$667	+\$68	+\$34	\$1,290
30" d 	INBW3042	42	29.675	\$362	+\$38	+\$19	\$995
	INBW3048	48	29.675	\$413	+\$43	+\$22	\$1,051
	INBW3054	54	29.675	\$464	+\$48	+\$23	\$1,110
	INBW3060	60	29.675	\$518	+\$53	+\$26	\$1,169
	INBW3072	72	29.675	\$620	+\$63	+\$30	\$1,284
	INBW3084	84	29.675	\$754	+\$79	+\$39	\$1,375
	INBW3096	96	29.675	\$889	+\$92	+\$46	\$1,480
36" d 	INBW3642	42	35.675	\$420	+\$43	+\$64	\$1,155
	INBW3648	48	35.675	\$478	+\$50	+\$74	\$1,237
	INBW3654	54	35.675	\$538	+\$56	+\$82	\$1,306
	INBW3660	60	35.675	\$601	+\$62	+\$90	\$1,416
	INBW3672	72	35.675	\$718	+\$72	+\$99	\$1,557

Rectangular Inscape Bench Worksurface



-1 1/4" thick

- Worksurfaces are to be specified with end support being the Full End Gable

- Nuform, Laminate & Veneer

- Straight & Tapered edge available on Nuform

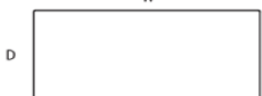
- 84" and 96" worksurfaces require same support as two surfaces

Description	Product No.	Actual Width	Depth	Nuform Solid /Laminate Straight Edge	Nuform Woodgrain/ Pattern	Nuform Tapered Edge	Veneer (Straight Edge ONLY)
Rectangular Worksurface							
Full End Gable Application							
24" d 	INBWE2442	44.75	23.675	\$303	+\$32	+\$15	\$886
	INBWE2448	50.75	23.675	\$348	+\$37	+\$17	\$941
	INBWE2454	56.75	23.675	\$391	+\$42	+\$21	\$993
	INBWE2460	62.75	23.675	\$434	+\$45	+\$23	\$1,061
	INBWE2472	74.75	23.675	\$522	+\$54	+\$26	\$1,152
	INBWE2484	86.75	23.675	\$611	+\$63	+\$29	\$1,256
	INBWE2496	98.75	23.675	\$700	+\$71	+\$36	\$1,355
30" d 	INBWE3042	44.75	29.675	\$380	\$40	+\$20	\$1,045
	INBWE3048	50.75	29.675	\$434	\$45	+\$23	\$1,104
	INBWE3054	56.75	29.675	\$487	\$50	+\$24	\$1,166
	INBWE3060	62.75	29.675	\$544	\$56	+\$27	\$1,227
	INBWE3072	74.75"	29.675	\$651	\$66	+\$32	\$1,348
	INBWE3084	86.75"	29.675	\$792	\$83	+\$41	\$1,444
	INBWE3096	98.75	29.675	\$933	\$97	+\$48	\$1,554
36" d 	INBWE3642	44.75	35.675	\$441	+\$45	+\$67	\$1,213
	INBWE3648	50.75	35.675	\$502	+\$53	+\$78	\$1,299
	INBWE3654	56.75	35.675	\$565	+\$59	+\$86	\$1,371
	INBWE3660	62.75	35.675	\$631	+\$65	+\$95	\$1,487
	INBWE3672	74.75	35.675	\$754	+\$76	+\$104	\$1,635

Rectangular Inscape Bench Worksurface

- 1 1/4" thick
- Worksurfaces are to be specified with Open "H" Leg end support
- Nuform, Laminate & Veneer
- Straight & Tapered edge available on Nuform
- 84" and 96" worksurfaces require same support as two surfaces
- Woodgrain pattern when applied on Worksurface Extension will run perpendicularly to main worksurfaces
- Worksurface Extension only to be used with Open "H" Leg end support

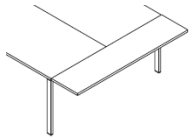
Description	Product No.	Actual Width	Depth	Nuform Solid /Laminate Straight Edge	Nuform Woodgrain/ Pattern	Nuform Tapered Edge	Veneer (Straight Edge ONLY)
Rectangular Worksurface							
Open "H" Leg Application							
24" d	INBWO2442	44.036	23.675	\$303	+\$32	+\$15	\$886
	INBWO2448	50.036	23.675	\$348	+\$37	+\$17	\$941
	INBWO2454	56.036	23.675	\$391	+\$42	+\$21	\$993
	INBWO2460	62.036	23.675	\$434	+\$45	+\$23	\$1,061
	INBWO2472	74.036	23.675	\$522	+\$54	+\$26	\$1,152
	INBWO2484	86.036	23.675	\$611	+\$63	+\$29	\$1,256
	INBWO2496	98.036	23.675	\$700	+\$71	+\$36	\$1,355
30"	INBWO3042	44.036	29.675	\$380	\$40	+\$20	\$1,045
	INBWO3048	50.036	29.675	\$434	\$45	+\$23	\$1,104
	INBWO3054	56.036	29.675	\$487	\$50	+\$24	\$1,166
	INBWO3060	62.036	29.675	\$544	\$56	+\$27	\$1,227
	INBWO3072	74.036	29.675	\$651	\$66	+\$32	\$1,348
	INBWO3084	86.036	29.675	\$792	\$83	+\$41	\$1,444
	INBWO3096	98.036	29.675	\$933	\$97	+\$48	\$1,554
36"	INBWO3642	44.036	35.675	\$441	+\$45	+\$67	\$1,213
	INBWO3648	50.036	35.675	\$502	+\$53	+\$78	\$1,299
	INBWO3654	56.036	35.675	\$565	+\$59	+\$86	\$1,371
	INBWO3660	62.036	35.675	\$631	+\$65	+\$95	\$1,487
	INBWO3672	74.036	35.675	\$754	+\$76	+\$104	\$1,635
Worksurface Extension							
	INBWX1848	51.35	18	\$441	+\$35	+\$16	\$1,200
	INBWX1860	63.35	18	\$499	+\$43	+\$22	\$1,287
	INBWX1872	75.35	18	\$615	+\$51	+\$25	\$1,399

Rectangular Inscape Bench Worksurface

-1 1/4" thick

- Worksurfaces are to be specified when storage is being used as end support

- Nuform, Laminate & Veneer

- Straight & Tapered edge available on Nuform

- 84" and 96" worksurfaces require same support as two surfaces

Description	Product No.	Actual Width	Depth	Nuform Solid /Laminate Straight Edge	Nuform Woodgrain/ Pattern	Nuform Tapered Edge	Veneer (Straight Edge ONLY)
Rectangular Worksurface							
End Storage Application							
24" d							
	INBWF2442	42.30	23.675	\$303	+\$32	+\$15	\$886
	INBWF2448	48.30	23.675	\$348	+\$37	+\$17	\$941
	INBWF2454	54.30	23.675	\$391	+\$42	+\$21	\$993
	INBWF2460	60.30	23.675	\$434	+\$45	+\$23	\$1,061
	INBWF2472	72.30	23.675	\$522	+\$54	+\$26	\$1,152
	INBW2F484	84.30	23.675	\$611	+\$63	+\$29	\$1,256
	INBWF2496	96.30	23.675	\$700	+\$71	+\$36	\$1,355
30" d							
	INBWF3042	42.30	29.675	\$380	\$40	+\$20	\$1,045
	INBWF3048	48.30	29.675	\$434	\$45	+\$23	\$1,104
	INBWF3054	54.30	29.675	\$487	\$50	+\$24	\$1,166
	INBWF3060	60.30	29.675	\$544	\$56	+\$27	\$1,227
	INBWF3072	72.30	29.675	\$651	\$66	+\$32	\$1,348
	INBWF3084	84.30	29.675	\$792	\$83	+\$41	\$1,444
	INBWF3096	96.30	29.675	\$933	\$97	+\$48	\$1,554
36" d							
	INBWF3642	42.30	35.675	\$441	+\$45	+\$67	\$1,213
	INBWF3648	48.30	35.675	\$502	+\$53	+\$78	\$1,299
	INBWF3654	54.30	35.675	\$565	+\$59	+\$86	\$1,371
	INBWF3660	60.30	35.675	\$631	+\$65	+\$95	\$1,487
	INBWF3672	72.30	35.675	\$754	+\$76	+\$104	\$1,635

Bench Electrical Access Worksurface

- 1 1/4" thick
- Worksurfaces are to be specified with any Inscape Bench spine in a middle or non-end position
- Laminate & Veneer
- 84" and 96" worksurfaces require same support as two surfaces
- see Inscape Bench Application Guide for cut-out placement and quantities on various widths

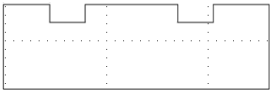
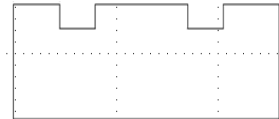
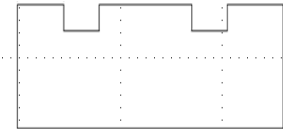
Description	Product No.	Width	Depth	Laminate	Veneer
Rectangular Electrical Access Worksurface					
Middle Application					
24" d					
	INBWEA2448	48	23.675	\$662	\$1,792
	INBWEA2454	54	23.675	\$744	\$1,892
	INBWEA2460	60	23.675	\$826	\$2,020
	INBWEA2472	72	23.675	\$994	\$2,194
	INBWEA2484	84	23.675	\$1,164	\$2,392
	INBWEA2496	96	23.675	\$1,334	\$2,580
30" d					
	INBWEA3048	48	29.675	\$836	\$2,102
	INBWEA3054	54	29.675	\$928	\$2,220
	INBWEA3060	60	29.675	\$1,036	\$2,338
	INBWEA3072	72	29.675	\$1,240	\$2,568
	INBWEA3084	84	29.675	\$1,508	\$2,750
	INBWEA3096	96	29.675	\$1,778	\$2,960
36" d					
	INBWEA3648	48	35.675	\$1,004	\$2,474
	INBWEA3654	54	35.675	\$1,130	\$2,612
	INBWEA3660	60	35.675	\$1,262	\$2,832
	INBWEA3672	72	35.675	\$1,508	\$3,114

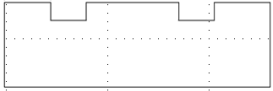
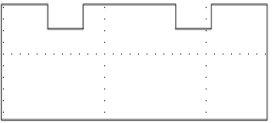
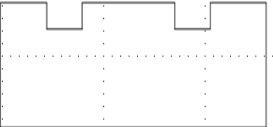

Bench Electrical Access Worksurface

- 1 1/4" thick
- Worksurfaces are to be specified when Full End Gables are used as end support
- Laminate & Veneer
- 84" and 96" worksurfaces require same support as two surfaces
- see Application Guide for cut-out placement and quantities on various widths as well as left and right handed placement
- place left hand version if end support is on left side, place right hand version if end support is on right side

Description	Product No.	Width	Actual		Laminate	Veneer
			Width	Depth		
Rectangular Electrical Access Worksurface						
Full End Gable Application - left						
24" d 	INBWEAEL2448	48	50.75	23.675	\$695	\$1,882
	INBWEAEL2454	54	56.75	23.675	\$781	\$1,987
	INBWEAEL2460	60	62.75	23.675	\$867	\$2,121
	INBWEAEL2472	72	74.75	23.675	\$1,044	\$2,304
	INBWEAEL2484	84	86.75	23.675	\$1,222	\$2,512
	INBWEAEL2496	96	98.75	23.675	\$1,401	\$2,709
30" d 	INBWEAEL3048	48	50.75	29.675	\$867	\$2,207
	INBWEAEL3054	54	56.75	29.675	\$974	\$2,331
	INBWEAEL3060	60	62.75	29.675	\$1,088	\$2,455
	INBWEAEL3072	72	74.75	29.675	\$1,302	\$2,696
	INBWEAEL3084	84	86.75	29.675	\$1,583	\$2,888
	INBWEAEL3096	96	98.75	29.675	\$1,867	\$3,108
36" d 	INBWEAEL3648	48	50.75	35.675	\$1,004	\$2,598
	INBWEAEL3654	54	56.75	35.675	\$1,130	\$2,743
	INBWEAEL3660	60	62.75	35.675	\$1,262	\$2,974
	INBWEAEL3672	72	74.75	35.675	\$1,508	\$3,270

Bench Electrical Access Worksurface

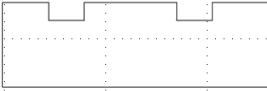
- 1 1/4" thick
- Worksurfaces are to be specified when Full End Gables are used as end support
- Laminate & Veneer
- 84" and 96" worksurfaces require same support as two surfaces
- see Application Guide for cut-out placement and quantities on various widths as well as left and right handed placement
- place left hand version if end support is on left side, place right hand version if end support is on right side

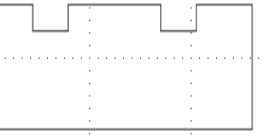
Description	Product No.	Width	Actual		Laminate	Veneer
			Width	Depth		
Rectangular Electrical Access Worksurface						
Full End Gable Application - right						
24"d 	INBWEAER2448	48	50.75	23.675	\$695	\$1,882
	INBWEAER2454	54	56.75	23.675	\$781	\$1,987
	INBWEAER2460	60	62.75	23.675	\$867	\$2,121
	INBWEAER2472	72	74.75	23.675	\$1,044	\$2,304
	INBWEAER2484	84	86.75	23.675	\$1,222	\$2,512
	INBWEAER2496	96	98.75	23.675	\$1,401	\$2,709
30"d 	INBWEAER3048	48	50.75	29.675	\$867	\$2,207
	INBWEAER3054	54	56.75	29.675	\$974	\$2,331
	INBWEAER3060	60	62.75	29.675	\$1,088	\$2,455
	INBWEAER3072	72	74.75	29.675	\$1,302	\$2,696
	INBWEAER3084	84	86.75	29.675	\$1,583	\$2,888
	INBWEAER3096	96	98.75	29.675	\$1,867	\$3,108
36"d 	INBWEAER3648	48	50.75	35.675	\$1,004	\$2,598
	INBWEAER3654	54	56.75	35.675	\$1,130	\$2,743
	INBWEAER3660	60	62.75	35.675	\$1,262	\$2,974
	INBWEAER3672	72	74.75	35.675	\$1,508	\$3,270

Bench Electrical Access Worksurface

- 1 1/4" thick
- Worksurfaces are to be specified when the Open "H" Leg are used as end support
- Laminate & Veneer
- 84" and 96" worksurfaces require same support as two surfaces
- see Application Guide for cut-out placement and quantities on various widths as well as left and right handed placement
- place left hand version if end support is on left side, place right hand version if end support is on right side

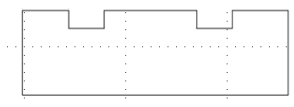
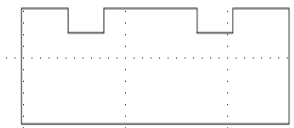
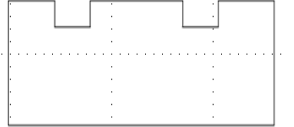
Description	Product No.	Width	Actual		Laminate	Veneer
			Width	Depth		
Rectangular Electrical Access Worksurface						
Open "H" Leg Application - left	INBWEAOL2448	48	50.036	23.675	\$695	\$1,882
24"d	INBWEAOL2454	54	56.036	23.675	\$781	\$1,987
	INBWEAOL2460	60	62.036	23.675	\$867	\$2,121
	INBWEAOL2472	72	74.036	23.675	\$1,044	\$2,304
	INBWEAOL2484	84	86.036	23.675	\$1,222	\$2,512
	INBWEAOL2496	96	98.036	23.675	\$1,401	\$2,709
30"d	INBWEAOL3048	48	50.036	29.675	\$867	\$2,207
	INBWEAOL3054	54	56.036	29.675	\$974	\$2,331
	INBWEAOL3060	60	62.036	29.675	\$1,088	\$2,455
	INBWEAOL3072	72	74.036	29.675	\$1,302	\$2,696
	INBWEAOL3084	84	86.036	29.675	\$1,583	\$2,888
	INBWEAOL3096	96	98.036	29.675	\$1,867	\$3,108
36"d	INBWEAOL3648	48	50.036	35.675	\$1,004	\$2,598
	INBWEAOL3654	54	56.036	35.675	\$1,130	\$2,743
	INBWEAOL3660	60	62.036	35.675	\$1,262	\$2,974
	INBWEAOL3672	72	74.036	35.675	\$1,508	\$3,270

Bench Electrical Access Worksurface

- 1 1/4" thick
- Worksurfaces are to be specified when the Open "H" Leg are used as end support
- Laminate & Veneer
- 84" and 96" worksurfaces require same support as two surfaces
- see Application Guide for cut-out placement and quantities on various widths as well as left and right handed placement
- place left hand version if end support is on left side, place right hand version if end support is on right side

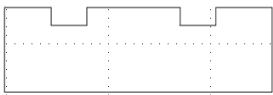
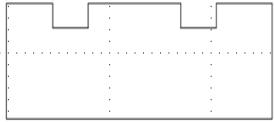
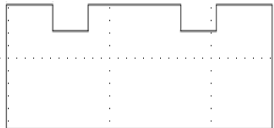
Description	Product No.	Width	Actual Width	Depth	Laminate	Veneer
Rectangular Electrical Access Worksurface						
Open "H" Leg Application - right 24"d 	INBWEAOR2448	48	50.036	23.675	\$695	\$1,882
	INBWEAOR2454	54	56.036	23.675	\$781	\$1,987
	INBWEAOR2460	60	62.036	23.675	\$867	\$2,121
	INBWEAOR2472	72	74.036	23.675	\$1,044	\$2,304
	INBWEAOR2484	84	86.036	23.675	\$1,222	\$2,512
	INBWEAOR2496	96	98.036	23.675	\$1,401	\$2,709
30"d 	INBWEAOR3048	48	50.036	29.675	\$867	\$2,207
	INBWEAOR3054	54	56.036	29.675	\$974	\$2,331
	INBWEAOR3060	60	62.036	29.675	\$1,088	\$2,455
	INBWEAOR3072	72	74.036	29.675	\$1,302	\$2,696
	INBWEAOR3084	84	86.036	29.675	\$1,583	\$2,888
	INBWEAOR3096	96	98.036	29.675	\$1,867	\$3,108
36"d 	INBWEAOR3648	48	50.036	35.675	\$1,004	\$2,598
	INBWEAOR3654	54	56.036	35.675	\$1,130	\$2,743
	INBWEAOR3660	60	62.036	35.675	\$1,262	\$2,974
	INBWEAOR3672	72	74.036	35.675	\$1,508	\$3,270

Height Adjustable Worksurface

- 1 1/4" thick
- Straight & Tapered edge
- Nuform, Laminate & Veneer
- End units are 1/2" shorter in length and Middle units are 1/2" shorter on each end eliminating potential pinch points
- only to be installed on Full Height Panel option - with either full height end gable or open "H" leg
- *See Inscape Bench Application Guide for details on how to specify

- when specifying the height adjustable worksurfaces, all units within bench must be height adjustable

INBEZxx = Middle-of-Run
 INBEZExx = End Gable
 INBEZOExx = Open "H" Leg

Description	Product No.	Actual Width	Depth	Nuform Solid/ Laminate - Straight Edge	Nuform Woodgrain/ Pattern	Nuform - Tapered Edge	Veneer (Straight Edge ONLY)
Spine Mounted Height Adjustable Worksurface							
Middle Application	INBEZ2436	35	23.675	\$1,862	+\$29	+\$13	\$2,381
	INBEZ2442	41	23.675	\$1,885	+\$30	+\$14	\$2,440
	INBEZ2448	47	23.675	\$1,927	+\$35	+\$16	\$2,492
	INBEZ2454	53	23.675	\$1,979	+\$40	+\$20	\$2,553
	INBEZ2460	59	23.675	\$2,020	+\$43	+\$22	\$2,617
	INBEZ2472	71	23.675	\$2,404	+\$51	+\$25	\$3,004
	INBEZ3036	35	29.675	\$1,930	+\$29	+\$13	\$2,526
	INBEZ3042	41	29.675	\$1,969	+\$30	+\$14	\$2,602
	INBEZ3048	47	29.675	\$2,020	+\$35	+\$16	\$2,658
	INBEZ3054	53	29.675	\$2,280	+\$40	+\$20	\$2,926
	INBEZ3060	59	29.675	\$2,334	+\$43	+\$22	\$2,985
	INBEZ3072	71	29.675	\$2,522	+\$51	+\$25	\$3,186



Spine Mounted Height Adjustable Worksurface							
Full End Gable Application	INBEZE2436	38.25	23.675	\$1,862	+\$29	+\$13	\$2,381
	INBEZE2442	44.25	23.675	\$1,885	+\$30	+\$14	\$2,440
	INBEZE2448	50.25	23.675	\$1,927	+\$35	+\$16	\$2,492
	INBEZE2454	56.25	23.675	\$1,979	+\$40	+\$20	\$2,553
	INBEZE2460	62.25	23.675	\$2,020	+\$43	+\$22	\$2,617
	INBEZE2472	74.75	23.675	\$2,404	+\$51	+\$25	\$3,004
	INBEZE3036	38.25	29.675	\$1,930	+\$29	+\$13	\$2,526
	INBEZE3042	44.25	29.675	\$1,969	+\$30	+\$14	\$2,602
	INBEZE3048	50.25	29.675	\$2,020	+\$35	+\$16	\$2,658
	INBEZE3054	56.25	29.675	\$2,280	+\$40	+\$20	\$2,926
	INBEZE3060	62.25	29.675	\$2,334	+\$43	+\$22	\$2,985
	INBEZE3072	74.75	29.675	\$2,522	+\$51	+\$25	\$3,186



Height Adjustable Worksurface

- 1 1/4" thick
- Straight & Tapered edge
- Nuform, Laminate & Veneer
- End units are 1/2" shorter in length and Middle units are 1/2" shorter on each end in order to eliminate potential pinch points
- only to be installed on Full Height Panel option - with either full height end gable or open "H" leg
- *See Inscape Bench Application Guide for details on how to specify
- when specifying the height adjustable worksurfaces, all units within bench must be height adjustable

INBEZxx = Middle-of-Run

INBEZExx = End Gable





INBEZOExx = Open "H" Leg

Description	Inscape Product No.	Actual Width	Depth	Nuform Solid/ Laminate - Straight Edge	Nuform Woodgrain/ Pattern	Nuform - Tapered Edge	Veneer (Straight Edge ONLY)
Spine Mounted Height Adjustable Worksurface							
Open "H" Leg Application	INBEZOE2436	38.536	23.675	\$1,862	+\$29	+\$13	\$2,381
	INBEZOE2442	44.536	23.675	\$1,885	+\$30	+\$14	\$2,440
	INBEZOE2448	50.536	23.675	\$1,927	+\$35	+\$16	\$2,492
	INBEZOE2454	56.536	23.675	\$1,979	+\$40	+\$20	\$2,553
	INBEZOE2460	62.536	23.675	\$2,020	+\$43	+\$22	\$2,617
	INBEZOE2472	74.536	23.675	\$2,404	+\$51	+\$25	\$3,004
	INBEZOE3036	38.536	29.675	\$1,930	+\$29	+\$13	\$2,526
	INBEZOE3042	44.536	29.675	\$1,969	+\$30	+\$14	\$2,602
	INBEZOE3048	50.536	29.675	\$2,020	+\$35	+\$16	\$2,658
	INBEZOE3054	56.536	29.675	\$2,280	+\$40	+\$20	\$2,926
	INBEZOE3060	62.536	29.675	\$2,334	+\$43	+\$22	\$2,985
	INBEZOE3072	74.536	29.675	\$2,522	+\$51	+\$25	\$3,186

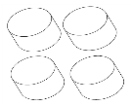

Worksurface Supports

- Cantilever brackets support worksurfaces at mid-span
- Spacers are to be specified in conjunction with 22.5" id cases and 3/8" thick tops to support worksurfaces
- Pedestal brackets dock pedestal cases to the benching spine *See Inscape Bench Application Guide
- Frame to Worksurface is to be specified in certain configurations where storage is the anchor *See Inscape Bench Application Guide

Description	Product No.	Height	List Price	
			Eco Black	Painted
Cantilever Bracket				
	INBRHCB		\$54	\$56
	INBLHCB		\$54	\$56
<hr/>				
Flush Bracket (kit of 4)				
	INFB		\$12	
<hr/>				
Spacers				
	(package of 4)	WSPACERLAT	1.3	\$51
	(package of 2)	WSPACERPED	1.3	\$26
<hr/>				
Pedestal Bracket				
	End location bracket	INBPEDLHBREDE		\$69
		INBPEDRHBREDE		\$69
	Middle location bracket	INBPEDLHBRMDE		\$69
		INBPEDRHBRMDE		\$69
<hr/>				
Frame to Worksurface Connection Bracket				
	INBSPWSBRKT			\$69



Worksurface Supports

- 3/8" thick tops are available in Nuform (straight edge), Laminate and Veneer
- tops are specified on 22.5" id cases along with spaces to support surfaces at 28.5"h

Description	Product No.	Thickness	List Price			
			<u>Nuform Solid</u>	<u>Nuform Woodgrain/ Pattern</u>	<u>Laminate</u>	<u>Veneer</u>
3/8" Storage Lateral Top 	INSWTOP1836	3/8	\$182	\$208	\$182	\$523
	INSWTOP1842	3/8	\$205	\$238	\$205	\$577
	INSWTOP1848	3/8	\$227	\$266	\$227	\$631
	INSWTOP1854	3/8	\$251	\$291	\$251	\$691
	INSWTOP1860	3/8	\$389	\$431	\$389	\$1,151
	INSWTOP1872	3/8	\$465	\$513	\$465	\$1,240
	INSWTOP1878	3/8	\$541	\$597	\$541	\$1,293
	<hr/>					
3/8" Storage Pedestal Top		Height				
	INBPEDTOP1522	28.5	\$84	\$95	\$446	
(for 9900 series)	INBPEDTOP1522.7	28.5	\$92	\$101	\$460	
	INBPEDTOP1528	28.5	\$105	\$116	\$473	
(for 9900 series)	INBPEDTOP1528.7	28.5	\$111	\$128	\$492	

End Supports

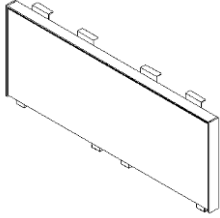
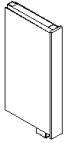
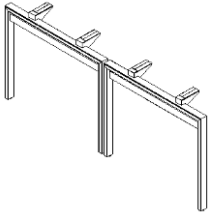
- When specifying a Full End Gable, choose the base then option of inside and outside tiles
- End gable unit has option of Nuform, laminate, paint, veneer or NO interior panel
- option "NO" interior tile when a Trading Desk unit is being installed
- Mid Support is available in paint both sides only
- Nuform, Laminate or Veneer with a pattern will run the length of the gable.

Description	Product No.	Width/ Depth	Height	Base	Paint	Nuform	Laminate	Veneer
Full End Gable								
	INBFEG28.548	48	28.5	\$705				
				inside	\$179	\$695	\$695	\$835
				outside	\$125	\$411	\$633	\$678
	INBFEG28.560	60	28.5	\$760				
				inside	\$181	\$742	\$742	\$953
				outside	\$266	\$426	\$639	\$797
	INBFEG28.572	72	28.5	\$781				
			inside	\$196	\$779	\$779	\$1,071	
			outside	\$273	\$450	\$646	\$917	
Mid Support - Full Gable								
	Fixed INBFEG28.512	12	28.5	\$524				
	INBFEG28.518	18	28.5	\$549				
Open "H" Leg								
	INBHEG28.548	48	28.5	\$796				
	INBHEG28.560	60	28.5	\$800				
	INBHEG28.572	72	28.5	\$883				
Mid Support - Open "H" Leg								
	Fixed INBHEG28.512	12	28.5	\$333				
	INBHEG28.518	18	28.5	\$372				

End Supports

- When specifying a Full End Gable, choose the base then option of inside and outside tiles
- Height Adjustable supports only for Full Height Spine
- End gable unit has option of Nuform, laminate, paint, veneer or NO interior panel
- Mid Support is available in paint both sides only
- Nuform, Laminate or Veneer with a pattern will run the length of the gable.

Description	Product No.	Width/ Depth	Height	Base	Paint	Nuform	Laminate	Veneer
-------------	-------------	-----------------	--------	------	-------	--------	----------	--------

Support for use with Height Adjustable Worksurfaces

**Full Height Spine Only

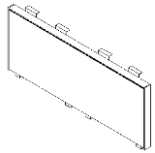

Full End Gable

INBFEG28.548

48

28.5

\$705

inside

\$179

\$695

\$695

\$835

outside

\$125

\$411

\$633

\$678

INBFEG28.560

60

28.5

\$760

inside

\$181

\$742

\$742

\$953

outside

\$266

\$426

\$639

\$797

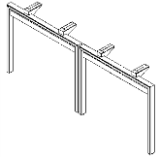

Open "H" Leg

INBHLEGHAW48

48

28.5

\$796

Height Adjustable

INBHLEGHAW60

60

28.5

\$800

for Worksurface

Mid Support - Height Adjustable Worksurface



INBFEGADJ12

12

28.5

\$524

INSCAPE BENCH ACCESSORIES

Accessories

General Information

Spine Accessories are units that may be specified to sit on top of any of the benching spines. The units are specified to include the stanchion kit or not (see notes on page). Height Adjustable worksurfaces must not be specified when spine accessories are specified due to interference with the lift mechanism. Items such as the Up-Mount Bin and Add on Glazing are taken from the Inscape System price list and are compatible.

Add-on Glazing is manufactured from 0.25 " tempered glass. Glazing may be mounted to the top of any equivalent Inscape Bench spine or combination of bases outlined in the Application Guide. Glazing is available in clear, etched one or two sides and designer glass Strie and Etre options. Add-on Glazing includes top trim, glass mounting extrusion and specified glass. Add-on Glazing is specified based on the thickness of the panel. Note: Hi-lo Add-on Glazing must be specified when installed directly adjacent to a higher panel at an inline situation only. The glaze and extrusion are inset on one side to allow for hi-lo vertical trim on the adjacent higher panel. If the situation calls for hi-lo on both sides, a special may be required. An Add on Glazing alignment clip is included with each Add on Glaze ordered.

Transaction Tops are specific to spine width they are to be installed on. Stanchions and top trim are included in the kit, as well as a 1" thick Nuform or laminate top. Hi-Lo Transaction Top must be specified when a transaction top is specified directly adjacent to a higher panel. The worksurface takes into account the profile of the end trim.

Note: 72", 84" and 96"w kits consist of two top caps and four stanchions (based on "Symmetrical Frame

Configuration" module lines). Top Caps can be specified as an option and are included with the kit.

The **Upmount Bin** is constructed of 24 gauge steel on the back and 20 gauge steel on bottom, sides and top. The Upmount Bin is ordered and shipped independent of the stanchion kit, top trim and accessories to hang on back of bin. The stanchion kit includes hardware to mount the stanchions on the crossrail of the frame and top trim (tapered or flat). Stanchion kits are specified based on thickness of frame in which the Upmount Bin is being installed. The backs of all Upmount Bins require either a whiteboard or a tackboard to provide a clean aesthetic. These accessories are specific to the Upmount Bin and include mounting hardware. The stanchion and Upmount Bin provide an overall height of 20.25" module matching adjacent panel heights. The bin is 12.75" deep and may be specified directly adjacent to another Upmount Bin facing the opposite direction; creating a "Twin- Bin" effect. Separate top cap and two stanchions will be required for each bin.

Open "H" Leg Accessories are units which hang from the Open "H" Leg on the Inscape Bench. These units are constructed of laminate and come complete with all brackets to hang. These units may be specified when a Height Adjustable worksurface is being specified. The units sit 2" lower than the worksurface so there is no concern of pinch points when lowering the worksurface. The Upper Bookcase is cantilevered over the end of the worksurface (similar to the Worksurface Extension). The weight capacity of shelves is 100 lbs and all other units are 200 lbs.

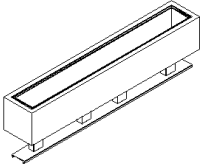
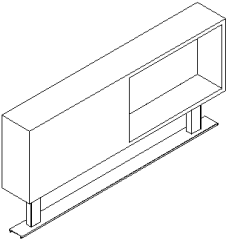
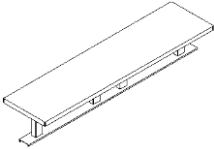

Spine Accessories

- Planter box, Cubbi Stor and Transaction Counter include stanchions kits and trim for spine mount
- Transaction Counter is available in 1" Nuform or Laminate
- Flat trim profile only
- Cubbi Stor and Planter box are constructed of laminate

Description	Product No.	Width	Height	Depth	List Price	
Planter Box						
	INBPLNTTOP-36	36	6	6	\$1,700	
	INBPLNTTOP-42	42	6	6	\$1,800	
	INBPLNTTOP-48	48	6	6	\$1,900	
	INBPLNTTOP-60	60	6	6	\$2,000	
Cubbi Stor						
	INBUPPCUBLH-30	30	13.6	6	\$1,605	
	INBUPPCUBLH-36	36	13.6	6	\$1,740	
	INBUPPCUBLH-42	42	13.6	6	\$2,009	
	INBUPPCUBLH-48	48	13.6	6	\$2,210	
	INBUPPCUBLH-54	54	13.6	6	\$2,290	
	INBUPPCUBLH-60	60	13.6	6	\$2,393	
	INBUPPCUBLH-72	72	13.6	6	\$2,502	
	INBUPPCUBRH-30	30	13.6	6	\$1,605	
	INBUPPCUBRH-36	36	13.6	6	\$1,740	
	INBUPPCUBRH-42	42	13.6	6	\$2,009	
	INBUPPCUBRH-48	48	13.6	6	\$2,210	
	INBUPPCUBRH-54	54	13.6	6	\$2,290	
	INBUPPCUBRH-60	60	13.6	6	\$2,393	
	INBUPPCUBRH-72	72	13.6	6	\$2,502	
Transaction Counter						
	INBTRANTOP-36	36		1	<u>Nuform</u> \$362	<u>Laminate</u> \$398
	INBTRANTOP-42	42		1	\$347	\$382
	INBTRANTOP-48	48		1	\$373	\$410
	INBTRANTOP-54	54		1	\$393	\$432
	INBTRANTOP-60	60		1	\$397	\$437
	INBTRANTOP-72	72		1	\$652	\$717

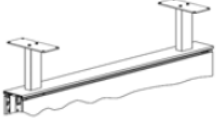
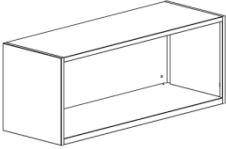

Spine Accessories

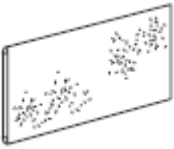
- Stanchion kit must be specified in conjunction with Up-Mount Bin
- Stanchion kits comes complete with stanchions, mounting hardware and flat top trim
- Up-mount overhead bins MUST always be specified to include a tackboard or whiteboard
- Overhead bin top is an optional aesthetic

Description	Product No.	Width	Height	Depth	List Price			
Stanchion Kit								
	INBUSKT30-2F	30	13.5	2.75	\$504			
	INBUSKT36-2F	36	13.5	2.75	\$520			
	INBUSKT42-2F	42	13.5	2.75	\$545			
	INBUSKT48-2F	48	13.5	2.75	\$556			
	INBUSKT54-2F	54	13.5	2.75	\$582			
	INBUSKT60-2F	60	13.5	2.75	\$638			
Up-Mount Overhead Bin								
	INPHUMB30	30	14		\$504			
	INPHUMB36	36	14		\$520			
	INPHUMB42	42	14		\$545			
	INPHUMB48	48	14		\$556			
	INPHUMB54	54	14		\$582			
	INPHUMB60	60	14		\$638			
Up-Mount Whiteboard								
	INUBWHB1430	30	14		\$35			
	INUBWHB1436	36	14		\$38			
	INUBWHB1442	42	14		\$44			
	INUBWHB1448	48	14		\$49			
	INUBWHB1454	54	14		\$56			
	INUBWHB1460	60	14		\$58			
Up-Mount Tackboard								
		Width	Height	Grade /COM	Grade 2	Grade3	Grade 5	Grade 7
	INUBTAC1430	30	14	\$148	\$150	\$155	\$168	\$207
	INUBTAC1436	36	14	\$150	\$157	\$165	\$182	\$230
	INUBTAC1442	42	14	\$155	\$163	\$171	\$188	\$238
	INUBTAC1448	48	14	\$159	\$168	\$175	\$195	\$247
	INUBTAC1454	54	14	\$162	\$169	\$179	\$204	\$249
INUBTAC1460	60	14	\$167	\$172	\$182	\$206	\$254	

Add on Glaze

- Add-on Glazing comes complete with mounting hardware and top cap
- Add-on Glazing may span multiple frames according to guidelines set in the Inscape Bench Application Guide
- Glaze is 0.25" thick tempered glass and available in 6.75", 10.125" and 13.5" heights with various finish options
- One glaze Alignment clip is included with each Add on Glaze

Description	Product No.	Width	Height	Clear	¼" thick			
					Etched 1	Etched 2	Stria	Etre
Add on Glaze - 6.75"h								
	INAG6.7530-2F	30	6.75	\$172	\$256	\$338	\$256	\$419
	INAG6.7536-2F	36	6.75	\$188	\$279	\$391	\$279	\$438
	INAG6.7542-2F	42	6.75	\$203	\$297	\$413	\$297	\$458
	INAG6.7548-2F	48	6.75	\$218	\$316	\$433	\$316	\$477
	INAG6.7554-2F	54	6.75	\$233	\$334	\$451	\$334	\$497
	INAG6.7560-2F	60	6.75	\$252	\$364	\$494	\$364	\$517
	INAG6.7566-2F	66	6.75	\$260	\$399	\$522	\$399	\$582
	INAG6.7572-2F	72	6.75	\$275	\$429	\$562	\$451	\$612
	INAG6.7578-2F	78	6.75	\$350	\$469	\$596	\$520	\$623
	INAG6.7584-2F	84	6.75	\$410	\$509	\$630	\$589	\$644
	INAG6.7590-2F	90	6.75	\$470	\$549	\$664	\$658	\$660
INAG6.7596-2F	96	6.75	\$530	\$589	\$700	\$699	\$681	
Add on Glaze - 10.125"h								
	INAG10.12530-2F	30	10.125	\$173	\$258	\$340	\$258	\$453
	INAG10.12536-2F	36	10.125	\$192	\$289	\$394	\$289	\$490
	INAG10.12542-2F	42	10.125	\$211	\$318	\$433	\$318	\$528
	INAG10.12548-2F	48	10.125	\$230	\$348	\$472	\$348	\$566
	INAG10.12554-2F	54	10.125	\$249	\$377	\$508	\$377	\$604
	INAG10.12560-2F	60	10.125	\$270	\$412	\$558	\$412	\$644
	INAG10.12566-2F	66	10.125	\$285	\$449	\$596	\$449	\$696
	INAG10.12572-2F	72	10.125	\$318	\$481	\$631	\$492	\$731
	INAG10.12578-2F	78	10.125	\$381	\$521	\$666	\$547	\$750
	INAG10.12584-2F	84	10.125	\$437	\$562	\$700	\$602	\$773
	INAG10.12590-2F	90	10.125	\$493	\$600	\$735	\$654	\$794
INAG10.12596-2F	96	10.125	\$550	\$641	\$771	\$696	\$818	
Add on Glaze - 13.5"h								
	INAG13.530-2F	30	13.5	\$174	\$260	\$341	\$260	\$486
	INAG13.536-2F	36	13.5	\$196	\$299	\$397	\$299	\$542
	INAG13.542-2F	42	13.5	\$219	\$339	\$453	\$339	\$597
	INAG13.548-2F	48	13.5	\$242	\$380	\$510	\$380	\$655
	INAG13.554-2F	54	13.5	\$265	\$419	\$565	\$419	\$710
	INAG13.560-2F	60	13.5	\$288	\$460	\$621	\$460	\$770
	INAG13.566-2F	66	13.5	\$310	\$499	\$670	\$499	\$810
	INAG13.572-2F	72	13.5	\$360	\$532	\$700	\$532	\$850
	INAG13.578-2F	78	13.5	\$412	\$573	\$735	\$573	\$876
	INAG13.584-2F	84	13.5	\$464	\$615	\$770	\$615	\$902
	INAG13.590-2F	90	13.5	\$516	\$650	\$806	\$650	\$928
INAG13.596-2F	96	13.5	\$569	\$692	\$841	\$692	\$954	



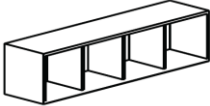
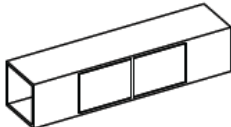
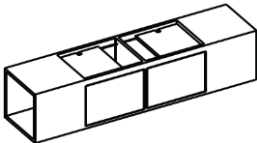
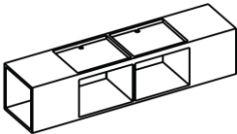
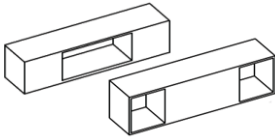
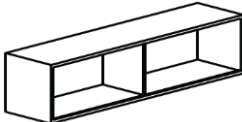

Open “H” Leg Accessories

- Lower units are hung from the Open “H” Leg
- May be specified when a Height Adjustable worksurface is installed adjacent to hanging unit *not Upper Bookcase
- Accessories are constructed of laminate
- specify units based on width of the bench

Description	Product No.	Width	Height	Depth	List Price	
Lower Bookcase						
	INBLWRBOOK-48	51.35	14.011	15	\$2,900	
	INBLWRBOOK-60	63.35	14.011	15	\$3,200	
	INBLWRBOOK-72	75.35	14.011	15	\$3,500	
Lower Bookcase with Recycling						
	INBLWRBREC-48	51.35	14.011	15	\$3,150	
	INBLWRBREC-60	63.35	14.011	15	\$3,400	
	INBLWRBREC-72	75.35	14.011	15	\$3,700	
Lower Bookcase with Personal Centre						
	INBLWRBPERS-48	51.35	14.011	15	\$3,800	
	INBLWRBPERS-60	63.35	14.011	15	\$4,200	
	INBLWRBPERS-72	75.35	14.011	15	\$4,500	
Personalized Side Access Bookcase						
	INBLWRPERSA-48	51.35	14.011	15	\$2,772	
	INBLWRPERSA-60	63.35	14.011	15	\$3,278	
	INBLWRPERSA-72	75.35	14.011	15	\$3,725	
Upper Bookcase						
	INBUPPBOOK-48	51.35	14.011	15	\$2,900	
	INBUPPBOOK-60	63.35	14.011	15	\$3,200	
	INBUPPBOOK-72	75.35	14.011	15	\$3,500	
Lower Bookcase with Sliding Panel						
	INBLWRBSLID-48	51.35	14.011	15	White Door	Frosted Door
	INBLWRBSLID-60	63.35	14.011	15	\$2,900	\$2,900
	INBLWRBSLID-72	75.35	14.011	15	\$3,200	\$3,200
					\$3,400	\$3,400

Open "H" Leg Accessories

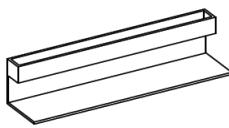
- Shelves, hook and acrylic modesty hang from open "H" leg
- Acrylic - white and frosted one side only
- All units may be specified adjacent to height adjustable worksurfaces
- Planter Box and Shelves are constructed of laminate

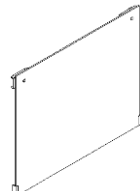
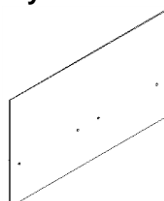
Description	Product No.	Width	Height	Depth	List Price	
Planter						
	INBPLNTEND-48	51.35	6	6	\$1,900	
	INBPLNTEND-60	63.35	6	6	\$2,100	
	INBPLNTEND-72	75.35	6	6	\$2,300	
Shelf						
	INBSHELF-48	51.35	14.011	13	\$1,200	
	INBSHELF-60	63.35	14.011	13	\$1,300	
	INBSHELF-72	75.35	14.011	13	\$1,400	
Shelf with Planter						
	INBSHELFPLT-48	51.35	14.011	13	\$3,100	
	INBSHELFPLT-60	63.35	14.011	13	\$3,300	
	INBSHELFPLT-72	75.35	14.011	13	\$3,500	
"H" Leg Accessory Hook						
	INBAHOOK				\$40	
Acrylic Modesty Panel					<u>White</u>	<u>Frosted</u>
	INBAMP-24	22.8	24.166		\$380	\$380
	INBAMP-30	28.8	24.166		\$445	\$445
	INBAMP-36	34.8	24.166		\$509	\$509
*inset into leg						
Acrylic Privacy Screen						
	INBAPS-1948	50.75	18.9		\$570	\$570
	INBAPS-1960	62.75	18.9		\$637	\$637
	INBAPS-1972	74.75	18.9		\$705	\$705
**modesty and privacy *matches 44"h overall	INBAPS-2948	50.75	28.75		\$720	\$720
	INBAPS-2960	62.75	28.75		\$757	\$757
	INBAPS-2972	74.75	28.75		\$925	\$925

INSCAPE BENCH STORAGE

Storage

General Information

Pedestals are of all-welded "wrap-around" construction of 20 and 22 gauge high quality, tension leveled, cold rolled steel. The steel gauges selected for drawer fronts, bodies and accessories ensure the highest quality durability and performance for all components. **All glides on cases must be specified as flat glides ($\frac{5}{8}$ " height adjustability) to work with Inscape Bench.** Pedestal corners (except for 7900) are welded at junction of top and case, eliminating horizontal lines for a cleaner, flush appearance, and strengthened with reinforcing gussets. A completely enclosed case provides rigid construction and dust-free interiors.

Box drawer sides are slotted on 1" centers to allow for maximum flexibility for drawer division. Double-wall construction allows lift-up doors to be picked up and recede smoothly, eliminates deformation, ensures flush fit within cabinet and improves lock performance. 7900 is single-wall construction. File (10.5" and 12") and EDP (15") drawer bodies have full-height sides to accommodate hanging file folders, eliminating the need for optional file frames. Fully progressive ball bearing suspensions on all drawers, including pencil and box drawers, are staged so that the left and right sides work in unison; this provides smooth drawer operation with minimum force. Staged suspensions allow the drawer to be completely pulled out, providing access to the entire drawer depth.

Special "claw-like" device incorporated in the suspension "grips" the fixed section of the suspension channel preventing drawer body bounce back or creep when drawer is closed. Modular interior allows complete interchangeability of drawer types within the pedestal case. For example, two 6" box drawers may be replaced by a 12" file drawer. Pedestals are standard with keyholes for attachment to underside of worksurface. For the 7900 only cases: 18" deep pedestals come standard with 18" deep drawers, 22" and 28" deep pedestals come standard with 22" deep drawers. For all other Series, pedestal drawers match case depth.

Worksurface supporting pedestals are designed for use with the Inscape Bench when used with flat glides. Worksurface supporting pedestals are available in two depths to fit 24" and 30" deep worksurfaces and support finished worksurface height of 28.5". Pedestals with 3", 6" or 7.5" drawers include one pencil tray per

pedestal. The 6" and 7.5" drawers also include a steel divider. The 10.5" and 12" drawers have one hang file suspension bar (two in a 28" deep pedestal) for side-to-side filing of legal or letter size folders or printout binders. 7900 Pedestals do not include any suspension bars.

Note: System storage pedestal cases consist of holes in the top of the case and back of the case to allow for worksurface docking and panel mounted brackets to be secured.

Cushion Mobile Pedestals (*See Inscape System Price List for this product) are topped with 1.25" thick Cal.117 fire-retardant polyurethane foam with a 2.2lb/ft. density. This upholstery cushion is balanced with a $\frac{7}{16}$ " board and is attached to a pedestal top with Velcro. Select from our graded upholstery program of solid color fabrics and vinyl's or choose COM option (Customers Own Material). To determine if a COM fabric has been preapproved for use on our cushion topper, contact your client services representative or go to www.inscapesolutions.com. For application of ALL fabrics, both from our graded program as well as COM (Customer Own Material) please specify layout orientation at time of order. If layout instructions are not provided Inscape will choose the direction to maximize production. Refer to the diagram for layout options.

After calculating the total amount of material needed in inches, divide the total number of inches by 36 for the total yardage and round up to the next full yard. Allow additional for repeat. Add 15% of total fabric required for small and medium pattern repeats. Add 20% of total fabric required for large patterns.

Due to the nature of the design and manufacture of our cushion, only approved fabrics will be accepted for application. For a description of the procedure required for COM fabric approval see sample 'Cushion COM Test Request' form found in the General Information section of this price list. This form can be downloaded from the Administration section of Insite or by contacting your client services representative for assistance.

Fabric lay up of Pedestal Cushions

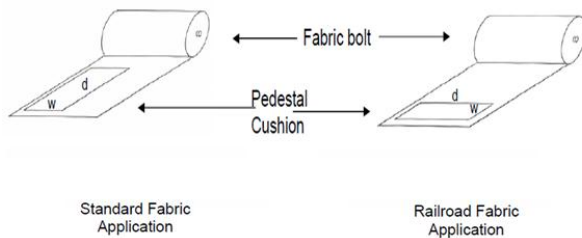

Pedestals come standard with lock. If lock is not required add suffix '/NL' after product number and deduct \$43 list per lock. Random keying is standard, and keyed alike may be ordered. Locks feature removable core and are standard with two keys, one of which has a black neoprene plastic key cover. Locks may be ordered for field installation. Specify cabinet height and width or model number. Note: Locks cannot be field installed on hinged door cabinets.

Lateral cabinets are of all-welded construction using 20 and 22 gauge high quality, tension leveled, and cold rolled steel. Drawer fronts, lift-up doors, roll-out shelves and all steel accessories are manufactured of the steel gauge appropriate to function at the highest quality level. **Laterals must be specified with flat glides to work with Inscape Bench.** Flat Glides provide 0.125" height adjustment when docked and 0.75" height adjustment if unit is not docked.

With the addition of counterweights where appropriate, cabinets meet all BIFMA specifications.

All interiors are completely modular and interchangeable so that cabinets can be retrofitted with new accessories and interiors as required. Cabinet corners (except for 7900) are welded at junction of top and case, eliminating horizontal lines for cleaner, flush appearance, and strengthened with reinforcing gussets. Double-wall construction allows lift-up doors to be picked up and receded smoothly, eliminates deformation, ensures flush fit within cabinet and improves lock performance. Lift-up door carrier mechanism has four nylon rollers two on each side - for smooth receding action with no binding or snagging. Self-closing, 110° opening, European style cupboard hinges for smooth door operations.

The absence of scissor mechanism in doors and drawers eliminates the potential for scissors binding, and facilitates

reconfiguration of cabinet openings as needed. Front leading edge of pullout shelves is beaded and rolled to provide grip for pullout action and strengthen shelf; front leading edge of fixed shelf is flat for easy removal of material. Fully progressive ball bearing suspension slides provide smooth action with minimum force.

Special "claw-like" device incorporated in suspension slide channel "grips" the fixed section of the suspension channel preventing drawer bounce-back or creep when drawer is closed. A patented Safelock™ interlock mechanism provides complete security and user safety against accidental opening of two or more drawers simultaneously. Lock fingers are configured with right angle bend upward not downward so that lift-up doors cannot be pulled down to disengage fingers from door slots and be forced to circumvent lock system. Lock bars operate vertically on both sides of cabinet for maximum security.

Knockouts that are included on case sides, top and bottom facilitate ganging and leveling. Glides - 2 in front and 2 in back - are adjustable from inside the cabinet so that cabinets can be leveled regardless of whether they are backed against a wall or banked.

9900 Series fronts have full width integral pulls with enamel finish to match case fronts. 7900 Series fronts are available with 2 pull options. The standard pull option is the radius aluminum pull. A rectangular aluminum pull option is also available at no additional cost. 7900 is single-wall construction. Nuform fronts include a Q- pull. Veneer fronts are available with 2 pull options. The standard Veneer pull option is the same Q- Pull that comes with the Nuform front. A continuous pull is also available on most veneer units.

Laterals include 1 pair of hang file bars in 10.5" and 12" fixed fronts, 1 EDP kit in 13.5" and 15" fixed fronts, pencil tray in 3" multi-file drawer and steel divider in 7.5" multi-file drawer, steel divider in 6" multi-file drawers and 3 divider plates in 13.5" lift-ups. Fixed shelf in lift-up is slotted in 1" increments. Lateral-to-panel bracket is required if lateral is positioned on-module.

Note: laterals and multi-files consist of slots in the back of the case to allow for panel mounted brackets to be secured.

Cabinets ship standard with single bitted lock. For applications requiring higher security a double bitted solution is available. If lock is not required it may be optioned as such. Random keying is standard, keyed

alike is optional. Cabinets originally ordered as non-locking may be field installed with the addition of locking bars and a lock core. Contact your client services representative for required parts. Locks may not be field installed in hinged door and sliding door cabinets. Master keys are available; refer to the accessories section to specify. Locks are standard with two keys, one of which has a black neoprene plastic cover.

All laterals are finished in standard 36.5° gloss baked enamel, electrostatically applied in a 2-coat process. Refer to the surface materials section for available colors. With the exception of custom micas, whites and metallic; custom colors are available at an up-charge and are be subject to extended lead times. For laterals specified in custom micas, specials whites or metallic, add an up-charge of 10% to the list price. All interior drawers/shelf bodies, exposed hardware (excluding European style hinges) hang file bars, dividers and media frames are finished in Eco Black.

Twin-Bins are 5.75" deep on each side of the supporting frame. Twin-Bins may be specified to install in both the lower and upper position of the frame. Bins are manufactured from minimum 20 gauge steel with an extruded aluminum reinforced top. Double wall, sliding doors on each side of the unit, slide easily across the recessed groove built into the bin front. Twin-Bins are available with or without locks. The locking mechanism is individualized for each side of the unit, allowing for personal privacy on either side. Twin-Bins are available in 36", 42", 48" and 60" widths. Recommended maximum load for Twin-Bins is 3lbs per linear inch. Bins are finished in standard 37.5° gloss baked enamel, electrostatically applied in a 2-coat process and are available in any of the colors shown in our Color Guide. Side pulls on Radius fronts are manufactured from ABS black plastic. Woodgrain fronts are available in any of our standard woodgrain finishes.

Handles are standard in aluminum finish and are located on the front of the sliding door. Case may still be ordered in any of the colors shown in our Color Guide.

The **Electrified Twin Bin** is built on the same premise as the standard Twin Bin with the addition of electrical and a sliding door with locking capabilities in two positions. All electrical components are specified separately including power track, receptacles and jumper cables. The sliding door may lock either the binder storage portion (full depth of bin) or the electrified portion which is the center portion which is approximately 5"d. The back of the Electrified Twin

Bin may be clad with either a tackboard or whiteboard which are both specific to this storage unit. A shelf may also be optioned for the electrified portion which is field installed midway between top and bottom of opening. A gap in the shelf allows for the cord of an electronic unit to plug into duplex (located near base of opening) and still sit on top of shelf. NOTE: these accessories are NOT compatible with the standard Twin Bin.

* See Inscape Bench Application Guide for criteria on which heights of stack-on to use in conjunction with the Twin Bin and Electrified Twin Bin

Specify **Twin-Bin mounting brackets** separately according to location on frame. 1 bracket per Twin-Bin is required. When stacking Twin-Bins a 6.75" high tile minimum must separate the two. Do not specify over Power Track Kit.. It is not recommended to specify Twin-Bins on wing panels. Twin-Bins should only be specified on spine panels for adequate stability. *See Inscape Bench Application Guide for details.

Drawer Standard Equipment

Lockers and towers containing 3" or 6" drawers are provided with one pencil tray per cabinet. 6" drawers are additionally standard with one steel divider. 10.5", 12" and 15" letter-width file drawers have one suspension bar for side-to-side filing of letter or legal-size folders. Full-width pullout drawers are standard with one pair hang file bars for side-to-side suspended filing. Full-width fixed shelves are standard with 3 plate dividers. Optional accessories are available.

Glides

Overall heights are inclusive of metal glides. Heights may be increased up to 5/8" by extending the standard glide. Glides are accessible from inside the cabinet when the bottom drawer is fully extended or removed and may be adjusted with a 0.25" socket driver. Optional 1.5" stem glides are available. Specify and add \$24 list to the cabinet price. Requires field installation.

Front Details and Pull Options

9900 Series fronts have full width integral pulls with enamel finish to match case fronts. 7900 is single-wall construction. Refer to the images and chart below for pull application on 7900 Series, Nuform, Veneer and MDF fronts. A \$20 list upcharge per pull applies to FP007, FP008 and FP009.

<u>Pull</u>	<u>Application</u>	<u>Upcharge</u>
FP001	7900 Series, Nuform, Veneer	----
FP002	Veneer	----
FP004	7900 Series, Nuform, Veneer	----
FP005	7900 Series, Nuform, Veneer	----
FP006	MDF Pedestals	----
FP007	7900 Series, Nuform, Veneer	\$20
FP008	7900 Series, Nuform, Veneer	\$20
FP009	7900 Series, Nuform, Veneer	\$20

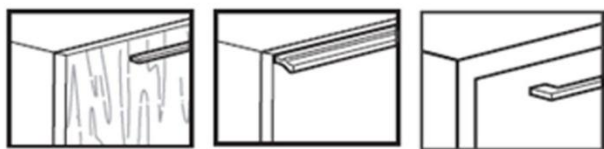

FP001

FP002

FP004

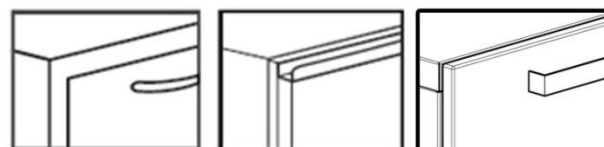

FP005

FP006

FP007

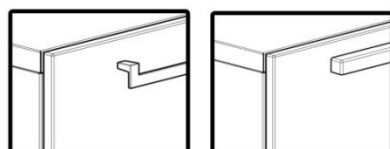

FP008

FP009

Workplace Towers and Lockers come standard with lock with single bitted lock. For applications requiring higher security, a double bitted solution is available. If lock is not required add suffix '/NL' after product number. Deduct \$51 list per lock. For lock location, see page 10. Locks are available in chrome and black finish. Specify. Random keying is standard. Files may be ordered keyed alike. Locks feature removable core and are standard with two keys, one of which has a black Neoprene plastic key cover. Cabinets originally ordered as non-locking may be field installed with the addition of locking bars and a lock core. Please contact Inscape Client Services for required parts. Locks may not be field installed in hinged and sliding door cabinets. Specify lateral file height and width or model number. Master keys are available at \$44 list.

Custom Colors

Inscape System offers color matched to a customers' specification when possible. This matching is done through a database of over 2,000 existing color formulas or the development of a new custom color. A minimum order value of \$3,000 net per custom color, applies to each order. A \$250 net fee applies for each custom color below this minimum. In addition, Custom premium colors (bright whites and bright colors; textured paints; and reflection paints that use mica, aluminum or special chemical to create their reflective properties) will be subject to a 10% upcharge to the net value of the product.

Lateral Storage for Inscape Bench



- Be sure to specify a 3/8" top along with spacers to achieve a 28.5" finished worksurface height

- **FLAT GLIDE ONLY when used with Inscape Bench

Description	Product No.	Width	Depth	List Price Flat Glide
9900 Series				
10.5" File, 12" File				
	INGE3022.5-F10F	30	18	\$842
	INGE3622.5-F10F	36	18	\$923
	INGE4222.5-F10F	42	18	\$1,015
<hr/>				
9900 Series				
2-6" Box, 10.5" File				
	INGE3022.52BF10	30	18	\$962
	INGE3622.52BF10	36	18	\$1,065
	INGE4222.52BF10	42	18	\$1,164
<hr/>				
9900 Series				
3" Pencil, 7.5" Box, 12" File				
	INGE3022.5-PB7F	30	18	\$863
	INGE3622.5-PB7F	36	18	\$946
	INGE4222.5-PB7F	42	18	\$1,034
<hr/>				
7900 Series				
10.5" File, 12" File				
	INGH3022.5-F10F	30	18	\$715
	INGH3622.5-F10F	36	18	\$784
	INGH4222.5-F10F	42	18	\$863
<hr/>				
7900 Series				
3" Pencil, 7.5" Box, 12" File				
	INGH3022.5-PB7F	30	18	\$854
	INGH3622.5-PB7F	36	18	\$931
	INGH4222.5-PB7F	42	18	\$1,012

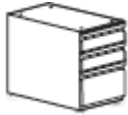

Pedestal Storage for Inscape Bench

- Be sure to specify a 3/8" top along with spacers to achieve a 28.5" finished worksurface height
- **FLAT GLIDE ONLY when used with Inscape Bench

Description	Product No.	Width	Depth	List Price Flat Glide
10.5" File, 12" File				
	INGE1522-F10F	15	22	\$704
	INGE1528-F10F	15	28	\$731
<hr/>				
2-6" Box, 10.5" File				
	INGE1522-2BF10	15	22	\$797
	INGE1528-2BF10	15	28	\$836
<hr/>				
3" Pencil, 7.5" Box, 12" File				
	INGE1522-PB7F	15	22	\$799
	INGE1528-PB7F	15	28	\$838
<hr/>				
10.5" File, 12" File				
	INGE1822-F10F	18	22	\$821
	INGE1828-F10F	18	28	\$855
<hr/>				
	INGE1822-2BF10	18	22	\$928
	INGE1828-2BF10	18	28	\$974
<hr/>				
3" Pencil, 7.5" Box, 12" File				
	INGE1822-PB7F	18	22	\$929
	INGE1828-PB7F	18	28	\$971
<hr/>				





Pedestal Storage for Inscape Bench

- Be sure to specify a 3/8" top along with spacers to achieve a 28.5" finished worksurface height
- **FLAT GLIDE ONLY when used with Inscape Bench

Description	Product No.	Width	Depth	Height	List Price Flat Glide
10.5" File, 12" File					
	INGH1522-F10F	15	22		\$563
	INGH1528-F10F	15	28		\$585
2-6" Box, 10.5" File					
	INGH1522-2BF10	15	22		\$637
	INGH1528-2BF10	15	28		\$668
3" Pencil, 7.5" Box, 12" File					
	INGH1522-PB7F	15	22		\$637
	INGH1528-PB7F	15	28		\$668

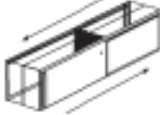

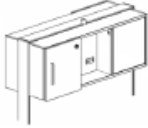
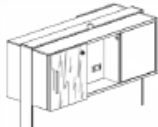
Twin Bin

- The mid and lower brackets include crossrails which are required for installation of Twin-Bin
- Frame crossrail is required to be cut on site to install the mid Twin- Bin bracket
- See Inscape Bench Application Guide for bracket details and locations
- Twin-Bin cannot be installed directly above a worksurface as it causes interference
- Jumper cables and duplexes for the Electrified Twin Bin power track specified separately
- The "UD" duplexes are to be specified in conjunction with the Electrified Twin Bin

Description	Product No.	Height	Width	List Price
Twin Bin - Nuform				
	INTWQB36LH	13.5	36	\$1,116
	INTWQB42LH	13.5	42	\$1,159
	INTWQB48LH	13.5	48	\$1,200
	INTWQB54LH	13.5	54	\$1,214
	INTWQB60LH	13.5	60	\$1,228
Twin Bin - Radius				
	INTWRB36LH	13.5	36	\$1,002
	INTWRB42LH	13.5	42	\$1,038
	INTWRB48LH	13.5	48	\$1,077
	INTWRB54LH	13.5	54	\$1,092
	INTWRB60LH	13.5	60	\$1,103
Twin Bin - Veneer				
	INTWVB36LH	13.5	36	\$1,717
	INTWVB42LH	13.5	42	\$1,769
	INTWVB48LH	13.5	48	\$1,866
	INTWVB54LH	13.5	54	\$2,008
	INTWVB60LH	13.5	60	\$2,259
Electrified Twin Bin				
	INETWB36LH	13.5	36	\$1,453
	INETWB42LH	13.5	42	\$1,520
	INETWB48LH	13.5	48	\$1,560
	INETWB54LH	13.5	54	\$1,578
	INETWB60LH	13.5	60	\$1,596
Electrified Twin Bin				
	INETWBV36LH	13.5	36	\$2,232
	INETWBV42LH	13.5	42	\$2,324
	INETWBV48LH	13.5	48	\$2,454
	INETWBV54LH	13.5	54	\$2,610
	INETWBV60LH	13.5	60	\$2,950
Twin Bin Bracket for install on a 20.25" Stack-on				
*includes crossrail	INTWBKTUH-36-2F		36	\$135
	INTWBKTUH-42-2F		42	\$137
	INTWBKTUH-48-2F		48	\$139
	INTWBKTUH-54-2F		54	\$141
	INTWBKTUH-60-2F		60	\$143
Twin Bin Bracket for install on a 27" Stack-on				
	INTWBKT-U			\$85

Trading Desk

- Kit includes all components to create cavity for technology in a back to back application
- End and middle units are specific to location being installed
- May only be specified with Full Height Benching Spine

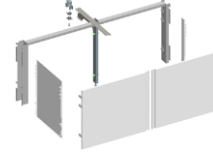
Description	Product No.	Width	Depth	List Price
30"d End Section Kit				
	INTD30E42	42	12	\$2219
	INTD30E48	48	12	\$2231
	INTD30E54	54	12	\$2273
	INTD30E60	60	12	\$2285
	INTD30E72	72	12	\$2600
30"d Middle Section Kit				
	INTD30M42	42	12	\$2017
	INTD30M48	48	12	\$2029
	INTD30M54	54	12	\$2071
	INTD30M60	60	12	\$2077
	INTD30M72	72	12	\$2362
36"d End Section Kit				
	INTD36E42	42	12	\$2761
	INTD36E48	48	12	\$2773
	INTD36E54	54	12	\$2814
	INTD36E60	60	12	\$2826
	INTD36E72	72	12	\$3148
36"d Middle Section Kit				
	INTD36M42	42	12	\$2559
	INTD36M48	48	12	\$2570
	INTD36M54	54	12	\$2612
	INTD36M60	60	12	\$2624
	INTD36M72	72	12	\$2910

7900 & 9900 PEDESTALS AND LATERALS
WITH NEW
RECTANGLAR GLIDES AND WORKSURFACE
SUPPORTING

7900 Front Pedestal w/Rectangular Glide

- Includes holes in top and bracket slots in back of case
- 15" letter width pedestal
- Worksurface supporting for 28.5" high
- Recommended installation below 1" worksurfaces or veneer only for clean aesthetic due to the tight corner radius of the worksurface

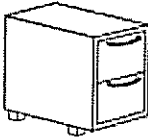
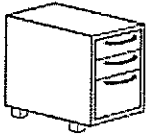
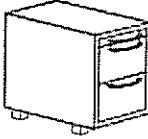
Description	Product No.	Height	Depth	Weight lbs.	List Price
10.5" File, 12" File 	INGH1522-F10F	27.25	22	100	\$587
	INGH1528-F10F	27.25	28	110	\$609
2-6" Box, 10.5" File 	INGH1522-2BF10	27.25	22	100	\$661
	INGH1528-2BF10	27.25	28	110	\$692
3" Pencil, 7.5" Box, 12" File 	INGH1522-PB7F	27.25	22	100	\$661
	INGH1528-PB7F	27.25	28	110	\$692

9900 Fronts Pedestal w/Rectangular Glide

- Includes holes in top and bracket slots in back of case
- Worksurface supporting for 28.5" high
- Recommended installation below 1" worksurfaces or veneer only for clean aesthetic due to the tight corner radius of the worksurface

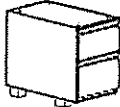
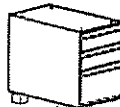
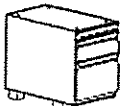
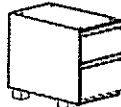
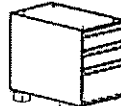
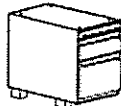
Description	Product No.	Height	Depth	Width	Weight lbs.	List Price
10.5" File, 12" File 	INGE1522-F10F	27.25	22	15	100	\$728
	INGE1528-F10F	27.25	28	15	110	\$755
2-6" Box, 10.5" File 	INGE1522-2BF10	27.25	22	15	100	\$821
	INGE1528-2BF10	27.25	28	15	110	\$860
3" Pencil, 7.5" Box, 12" File 	INGE1522-PB7F	27.25	22	15	100	\$823
	INGE1528-PB7F	27.25	28	15	110	\$862
Description	Product No.	Height	Depth		Weight lbs.	List Price
10.5" File, 12" File 	INGE1822-F10F	27.25	22	18	100	\$845
	INGE1828-F10F	27.25	28	18	110	\$879
2-6" Box, 10.5" File 	INGE1822-2BF10	27.25	22	18	100	\$952
	INGE1828-2BF10	27.25	28	18	110	\$998
3" Pencil, 7.5" Box, 12" File 	INGE1822-PB7F	27.25	22	18	100	\$953
	INGE1828-PB7F	27.25	28	18	100	\$995

7900 Front Lateral Storage w/Rectangular Glide

- Includes slots in back for lateral to panel bracket, no holes on top
- Laterals are 18" deep
- Worksurface supporting for 28.5" high
- Consult General Information on page D-4 for pull options

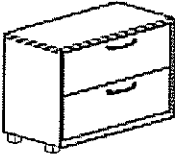
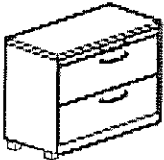
Description	Product No.	Height	Width	List Price
10.5" File, 12" File 	INGH3022.5-F10F	27.25	30	\$739
	INGH3622.5-F10F	27.25	36	\$808
	INGH4222.5-F10F	27.25	42	\$887
	<hr/>			
3" Pencil, 7.5" Box, 12" File 	INGH3022.5-PB7F	27.25	30	\$878
	INGH3622.5-PB7F	27.25	36	\$955
	INGH4222.5-PB7F	27.25	42	\$1036
	<hr/>			

9900 Front Lateral Storage w/Rectangular Glide

- Includes slots in back for lateral to panel bracket, no holes on top
- Laterals are 18" deep
- Worksurface supporting for 28.5" high

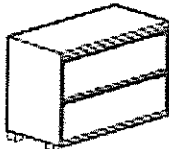
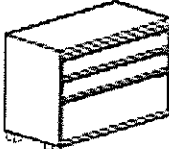
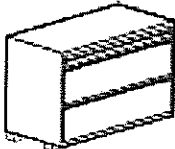
Description	Product No.	Height	Width	List Price
10.5" File, 12" File 	INGE3022.5-F10F	27.25	30	\$866
	INGE3622.5-F10F	27.25	36	\$947
	INGE4222.5-F10F	27.25	42	\$1039
	<hr/>			
2-6" Box, 10.5" File 	INGE3022.52BF10	27.25	30	\$986
	INGE3622.52BF10	27.25	36	\$1089
	INGE4222.52BF10	27.25	42	\$1188
	<hr/>			
3" Pencil, 7.5" Box, 12" File 	INGE3022.5-PB7F	27.25	30	\$887
	INGE3622.5-PB7F	27.25	36	\$970
	INGE4222.5-PB7F	27.25	42	\$1058
	<hr/>			

FREESTANDING AND PANEL ATTACHED LEGS

Freestanding and Panel Attached Legs

General Notes

The **Rectangular Post Leg** is a 2" x 1" leg is field installed and screwed to the underside of the worksurface. The rectangular leg comes in two options of either fixed (28.5" worksurface support) or adjustable (25.5", 27", 28.5", 30", 31.5"). The adjustment is made by using a 5mm HEX to manually adjust the leg vertically. Legs are available in all standard colors. Glide adjustment of the leg is 1 ½" for leveling purposes.

The **Triangular Leg** is a 2 ½" x 2 ½" leg which is field installed and screwed to the underside of the worksurface. This leg is available as a fixed version only. The interior of the leg includes a portion that may be slide up and down in order to accommodate wiring within the leg. This sliding portion may be painted an alternative color. This leg is available in all standard colors. Glide adjustment of the leg is 1 ½" for leveling purposes.

"O" Leg is a freestanding leg option which is available in all standard colors. This leg is fixed only and supports a worksurface of 28.5"h. The "O" leg is specific to the depth of the worksurface with which is to be supporting and is available in 24", 30" and 36" versions (nominal sizes). The worksurface will overhang .875" on either side of the leg. Glide adjustment of the leg is 1 ½" for leveling purposes.





"H" Leg is a freestanding leg option which has the ability to tie into panel via the **"H" Leg Docking Bracket**. This leg is available in all standard colors. There are two options for the "H" leg, fixed which supports a 28.5"h worksurface and an adjustable version which accommodates a height range of 25.5", 27", 28.5", 30" and 31.5". Be sure not to specify the adjustable leg version to tie into the panel as the height adjustment of the leg may differ from other supports. The "H" leg is specific to the depth of the worksurface with which is to be supporting and is available in 24", 30" and 36" versions (nominal sizes). The worksurface will overhang .875" on either side of the leg. Glide adjustment of the leg is 1 ½" for leveling purposes.

**This leg does NOT accommodate hanging storage components from the Inscape Bench; however the Accessory hook may be used.

The **Framed Support Leg** is the same as the previous version however it DOES NOT include the grey glide cap as the previous version did. This is a fixed support for 28.5"h worksurfaces and ties into the frame with its integral bracket. Glide adjustment of the leg is 1 ½" for leveling purposes.

**This leg does NOT accommodate hanging storage components from the Inscape Bench. Legs are available in all standard colors

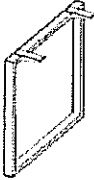
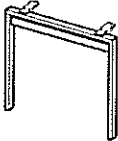
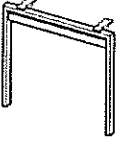
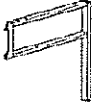
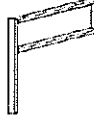
Freestanding and Panel Attached Legs

Description	Product No.	Width	Height	List Price
Rectangular Post Leg 	INRECPLEG-28.5		28.5	\$130
	INRECPLEG-ADJ		Adjustable	\$218
Triangular Leg 	INTWMLEG-28.5		28.5	\$197
"O" Leg 	INOLEG2428.5	24	28.5	\$309
	INOLEG3028.5	30	28.5	\$319
	INOLEG3628.5	36	28.5	\$322
"H" Leg <div style="display: flex; flex-direction: column; align-items: center;"> <div style="margin-bottom: 20px;"> <p>Fixed</p>  </div> <div> <p>Adjustable</p>  </div> </div>	INHLEG2428.5	24	28.5	\$372
	INHLEG3028.5	30	28.5	\$393
	INHLEG3628.5	36	28.5	\$406
	INHLEG24-ADJ	24	Adjustable	\$452
	INHLEG30-ADJ	30	Adjustable	\$472
	INHLEG36-ADJ	36	Adjustable	\$486
Framed Support Leg <div style="display: flex; flex-direction: column; align-items: center;"> <div style="margin-bottom: 20px;">  </div> <div style="margin-bottom: 20px;">  </div> <div>  </div> </div>	INLFRMLEG2428.5	24	28.5	\$300
	INLFRMLEG3028.5	30	28.5	\$336
	INLFRMLEG3628.5	36	28.5	\$374
	INRFRMLEG2428.5	24	28.5	\$300
	INRFRMLEG3028.5	30	28.5	\$336
	INRFRMLEG3628.5	36	28.5	\$374
	INCFRMLEG2428.5	24	28.5	\$300
	INCFRMLEG3028.5	30	28.5	\$336
	INCFRMLEG3628.5	36	28.5	\$374

**WARDROBE UNITS FREESTANDING AND
ELECTRIFIED VERSION**

General Notes

Wardrobe Units

Wardrobe units are available in two different variations; freestanding and an Electrified Storage version. The widths range from 12", 15" and 18" (the Electrified Storage version includes a 24" version). The freestanding version matches panel heights of 44", 51", 57" and 64" h. The Electrified Storage version matches 51" and 64" versions. Wardrobe units are available in 9900 series, Nuform solid/woodgrain and veneer for the Electrified Storage 24" version only. Wardrobe units include the option of a coat rod and upper shelf or multiple shelves (quantities listed below)

44" h version includes 2 shelves

51" h version includes 2 shelves

57" h version includes 2 shelves

64" h version includes 3 shelves

Wardrobe units are locking and include flat glides on the freestanding versions. Electrified Storage versions include round or rectangular glide.

9900 Series Wardrobe Tower

- Option of coat rod and upper shelf or multiple shelves
- See General Pages for multiple shelf quantities
- includes flat glide

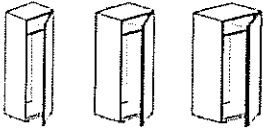
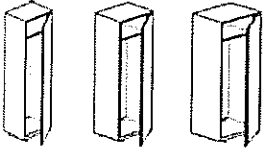
Description	Product No.	Depth	Width	Height	Coat Rod + Shelf	Shelves	
Wardrobe Tower to match 44" h panel							
	INVR121839E-HD	18"	12"	41.875"	\$999	\$999	
	INVR122439E-HD	24"	12"	41.875"	\$1,077	\$1,077	
	INVR151839E-HD	18"	15"	41.875"	\$1,077	\$1,077	
	INVR152439E-HD	24"	15"	41.875"	\$1,107	\$1,107	
	INVR181839E-HD	18"	18"	41.875"	\$1,107	\$1,107	
	INVR182439E-HD	24"	18"	41.875"	\$1,119	\$1,119	
	INVL121839E-HD	18"	12"	41.875"	\$999	\$999	
	INVL122439E-HD	24"	12"	41.875"	\$1,077	\$1,077	
	INVL151839E-HD	18"	15"	41.875"	\$1,077	\$1,077	
	INVL152439E-HD	24"	15"	41.875"	\$1,107	\$1,107	
	INVL181839E-HD	18"	18"	41.875"	\$1,107	\$1,107	
	INVL182439E-HD	24"	18"	41.875"	\$1,119	\$1,119	
	Wardrobe Tower to match 51" h panel						
		INVR121846E-HD	18"	12"	49.375"	\$1,080	\$1,080
INVR122446E-HD		24"	12"	49.375"	\$1,140	\$1,140	
INVR151846E-HD		18"	15"	49.375"	\$1,140	\$1,140	
INVR152446E-HD		24"	15"	49.375"	\$1,202	\$1,202	
INVR181846E-HD		18"	18"	49.375"	\$1,202	\$1,202	
INVR182446E-HD		24"	18"	49.375"	\$1,267	\$1,267	
INVL121846E-HD		18"	12"	49.375"	\$1,080	\$1,080	
INVL122446E-HD		24"	12"	49.375"	\$1,140	\$1,140	
INVL151846E-HD		18"	15"	49.375"	\$1,140	\$1,140	
INVL152446E-HD		24"	15"	49.375"	\$1,202	\$1,202	
INVL181846E-HD		18"	18"	49.375"	\$1,202	\$1,202	
INVL182446E-HD		24"	18"	49.375"	\$1,267	\$1,267	
Wardrobe Tower to match 57" h panel							
		INVR121852E-HD	18"	12"	55.375"	\$1,175	\$1,175
	INVR122452E-HD	24"	12"	55.375"	\$1,215	\$1,215	
	INVR151852E-HD	18"	15"	55.375"	\$1,215	\$1,215	
	INVR152452E-HD	24"	15"	55.375"	\$1,257	\$1,257	
	INVR181852E-HD	18"	18"	55.375"	\$1,257	\$1,257	
	INVR182452E-HD	24"	18"	55.375"	\$1,299	\$1,299	
	INVL121852E-HD	18"	12"	55.375"	\$1,175	\$1,175	
	INVL122452E-HD	24"	12"	55.375"	\$1,215	\$1,215	
	INVL151852E-HD	18"	15"	55.375"	\$1,215	\$1,215	
	INVL152452E-HD	24"	15"	55.375"	\$1,257	\$1,257	
	INVL181852E-HD	18"	18"	55.375"	\$1,257	\$1,257	
	INVL182452E-HD	24"	18"	55.375"	\$1,299	\$1,299	

9900 Series Wardrobe Tower

- Option of mitten shelf with coat rod or shelves
- See General Pages for multiple shelf quantities
- includes flat glide

Description	Product No.	Depth	Width	Height	Coat Rod + Shelf	Shelves
Wardrobe Tower to match 64" h panel	INVR121860E-HD	18"	12"	62.875"	\$1,199	\$1,199
	INVR122460E-HD	24"	12"	62.875"	\$1,267	\$1,267
	INVR151860E-HD	18"	15"	62.875"	\$1,267	\$1,267
	INVR152460E-HD	24"	15"	62.875"	\$1,303	\$1,303
	INVR181860E-HD	18"	18"	62.875"	\$1,303	\$1,303
	INVR182460E-HD	24"	18"	62.875"	\$1,340	\$1,340
	INVL121860E-HD	18"	12"	62.875"	\$1,199	\$1,199
	INVL122460E-HD	24"	12"	62.875"	\$1,267	\$1,267
	INVL151860E-HD	18"	15"	62.875"	\$1,267	\$1,267
	INVL152460E-HD	24"	15"	62.875"	\$1,303	\$1,303
	INVL181860E-HD	18"	18"	62.875"	\$1,303	\$1,303
	INVL182460E-HD	24"	18"	62.875"	\$1,340	\$1,340

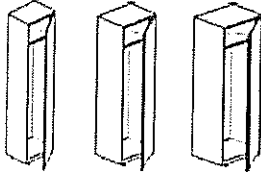

Nuform Wardrobe Tower

- Option of mitten shelf with coat rod or shelves
- See General Pages for multiple shelf quantities
- includes flat glide
- Nuform includes options of Solid or Woodgrain

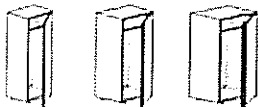
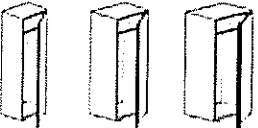
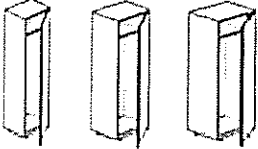
Description	Product No.	Depth	Width	Height	Coat Rod + Shelf	Shelves
Wardrobe Tower to match 44" h panel						
	INVR121839Q-HD	18"	12"	41.875"	\$1,199	\$1,199
	INVR122439Q-HD	24"	12"	41.875"	\$1,292	\$1,292
	INVR151839Q-HD	18"	15"	41.875"	\$1,292	\$1,292
	INVR152439Q-HD	24"	15"	41.875"	\$1,328	\$1,328
	INVR181839Q-HD	18"	18"	41.875"	\$1,328	\$1,328
	INVR182439Q-HD	24"	18"	41.875"	\$1,343	\$1,343
	INVL121839Q-HD	18"	12"	41.875"	\$1,199	\$1,199
	INVL122439Q-HD	24"	12"	41.875"	\$1,292	\$1,292
	INVL151839Q-HD	18"	15"	41.875"	\$1,292	\$1,292
	INVL152439Q-HD	24"	15"	41.875"	\$1,328	\$1,328
	INVL181839Q-HD	18"	18"	41.875"	\$1,328	\$1,328
	INVL182439Q-HD	24"	18"	41.875"	\$1,343	\$1,343
Wardrobe Tower to match 51" h panel						
	INVR121846Q-HD	18"	12"	49.75"	\$1,296	\$1,296
	INVR122446Q-HD	24"	12"	49.75"	\$1,368	\$1,368
	INVR151846Q-HD	18"	15"	49.75"	\$1,368	\$1,368
	INVR152446Q-HD	24"	15"	49.75"	\$1,442	\$1,442
	INVR181846Q-HD	18"	18"	49.75"	\$1,442	\$1,442
	INVR182446Q-HD	24"	18"	49.75"	\$1,520	\$1,520
	INVL121846Q-HD	18"	12"	49.75"	\$1,296	\$1,296
	INVL122446Q-HD	24"	12"	49.75"	\$1,368	\$1,368
	INVL151846Q-HD	18"	15"	49.75"	\$1,368	\$1,368
	INVL152446Q-HD	24"	15"	49.75"	\$1,442	\$1,442
	INVL181846Q-HD	18"	18"	49.75"	\$1,442	\$1,442
	INVL182446Q-HD	24"	18"	49.75"	\$1,520	\$1,520
Wardrobe Tower to match 57" h panel						
	INVR121852Q-HD	18"	12"	55.375"	\$1,410	\$1,410
	INVR122452Q-HD	24"	12"	55.375"	\$1,458	\$1,458
	INVR151852Q-HD	18"	15"	55.375"	\$1,458	\$1,458
	INVR152452Q-HD	24"	15"	55.375"	\$1,508	\$1,508
	INVR181852Q-HD	18"	18"	55.375"	\$1,508	\$1,508
	INVR182452Q-HD	24"	18"	55.375"	\$1,559	\$1,559
	INVL121852Q-HD	18"	12"	55.375"	\$1,410	\$1,410
	INVL122452Q-HD	24"	12"	55.375"	\$1,458	\$1,458
	INVL151852Q-HD	18"	15"	55.375"	\$1,458	\$1,458
	INVL152452Q-HD	24"	15"	55.375"	\$1,508	\$1,508
	INVL181852Q-HD	18"	18"	55.375"	\$1,508	\$1,508
	INVL182452Q-HD	24"	18"	55.375"	\$1,559	\$1,559

Nuform Wardrobe Tower

- Option of mitten shelf with coat rod or shelves
- See General Pages for multiple shelf quantities
- includes flat glide
- Nuform includes options of Solid or Woodgrain

Description	Product No.	Depth	Width	Height	Coat Rod + Shelf	Shelves
Wardrobe Tower to match 64" h panel	INVR121860Q-HD	18"	12"	62.875"	\$1,439	\$1,439
	INVR122460Q-HD	24"	12"	62.875"	\$1,520	\$1,520
	INVR151860Q-HD	18"	15"	62.875"	\$1,520	\$1,520
	INVR152460Q-HD	24"	15"	62.875"	\$1,564	\$1,564
	INVR181860Q-HD	18"	18"	62.875"	\$1,564	\$1,564
	INVR182460Q-HD	24"	18"	62.875"	\$1,608	\$1,608
	INVL121860Q-HD	18"	12"	62.875"	\$1,439	\$1,439
	INVL122460Q-HD	24"	12"	62.875"	\$1,520	\$1,520
	INVL151860Q-HD	18"	15"	62.875"	\$1,520	\$1,520
	INVL152460Q-HD	24"	15"	62.875"	\$1,564	\$1,564
	INVL181860Q-HD	18"	18"	62.875"	\$1,564	\$1,564
	INVL182460Q-HD	24"	18"	62.875"	\$1,608	\$1,608

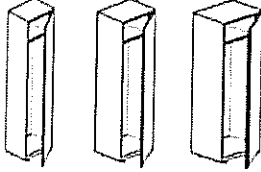

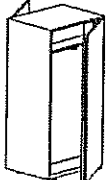
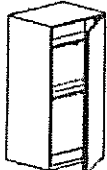
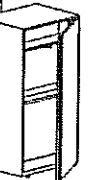

51" h 9900 Series Electrified Storage Wardrobe Cabinet

- Ganging hardware is included with wardrobe cabinet
- Matches overall height of 51"
- See General Pages for multiple shelf quantities
- Pass thru capability creates a horizontal septum where jumper cables may "pass thru" the case
- No electrical or data access in wardrobe units
- Consult General Information on page D-4 for pull options
- Nuform includes options of Solid or Woodgrain

Description	Product No.	Depth	Width	Height	Coat Rod +Shelf	Shelves	
9900 Series							
	Single Sided	SWVR121845E	18"	12"	49.98"	\$1,080	\$1,080
		SWVR151845E	18"	15"	49.98"	\$1,140	\$1,140
		SWVR181845E	18"	18"	49.98"	\$1,201	\$1,201
		SWVL121845E	18"	12"	49.98"	\$1,080	\$1,080
		SWVL151845E	18"	15"	49.98"	\$1,140	\$1,140
		SWVL181845E	18"	18"	49.98"	\$1,201	\$1,201
	Double Sided	SWWRR121845E	18"	12"	49.98"	\$1,280	\$1,280
		SWWLL121845E	18"	12"	49.98"	\$1,280	\$1,280
		SWWRL121845E	18"	12"	49.98"	\$1,280	\$1,280
		SWWRR151845E	18"	15"	49.98"	\$1,340	\$1,340
		SWWLL151845E	18"	15"	49.98"	\$1,340	\$1,340
		SWWRL151845E	18"	15"	49.98"	\$1,340	\$1,340
		SWWRR181845E	18"	18"	49.98"	\$1,400	\$1,400
		SWWLL181845E	18"	18"	49.98"	\$1,400	\$1,400
		SWWRL181845E	18"	18"	49.98"	\$1,400	\$1,400
		SWWRR2445E	18"	24"	49.98"	\$1675	N/A
		SWWLL2445E	18"	24"	49.98"	\$1675	N/A
	SWWRL2445E	18"	24"	49.98"	\$1675	N/A	
	Single Sided with pass thru capability	SWVR121845EP	18"	12"	49.98"	\$1,134	\$1,134
		SWVR151845EP	18"	15"	49.98"	\$1,197	\$1,197
		SWVR181845EP	18"	18"	49.98"	\$1,261	\$1,261
		SWVL121845EP	18"	12"	49.98"	\$1,134	\$1,134
		SWVL151845EP	18"	15"	49.98"	\$1,197	\$1,197
		SWVL181845EP	18"	18"	49.98"	\$1,261	\$1,261
	Double Sided with pass thru capability	SWWRR121845EP	18"	12"	49.98"	\$1,344	\$1,344
		SWWLL121845EP	18"	12"	49.98"	\$1,344	\$1,344
		SWWRL121845EP	18"	12"	49.98"	\$1,344	\$1,344
		SWWRR151845EP	18"	15"	49.98"	\$1,407	\$1,407
		SWWLL151845EP	18"	15"	49.98"	\$1,407	\$1,407
		SWWRL151845EP	18"	15"	49.98"	\$1,407	\$1,407
		SWWRR181845EP	18"	18"	49.98"	\$1,470	\$1,470
		SWWLL181845EP	18"	18"	49.98"	\$1,470	\$1,470
		SWWRL181845EP	18"	18"	49.98"	\$1,470	\$1,470
		SWWRR2445EP	18"	24"	49.98"	\$1838	N/A
		SWWLL2445EP	18"	24"	49.98"	\$1838	N/A
	SWWRL2445EP	18"	24"	49.98"	\$1838	N/A	

51" h Nuform Electrified Storage Wardrobe Cabinet

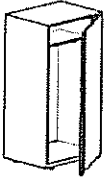
- Ganging hardware is included with wardrobe cabinet
- Matches overall height of 51"
- See General Pages for multiple shelf quantities
- Pass thru capability creates a horizontal septum where jumper cables may "pass thru" the case
- No electrical or data access in wardrobe units
- Consult General Information on page D-4 for pull options
- Nuform includes options of Solid or Woodgrain

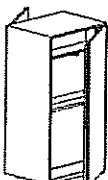
Description	Product No.	Depth	Width	Height	Coat Rod +Shelf	Shelves	
Nuform							
	Single Sided	SWVR121845Q	18"	12"	49.98"	\$1,296	\$1,296
		SWVR151845Q	18"	15"	49.98"	\$1,368	\$1,368
		SWVR181845Q	18"	18"	49.98"	\$1,441	\$1,441
		SWVL121845Q	18"	12"	49.98"	\$1,296	\$1,296
		SWVL151845Q	18"	15"	49.98"	\$1,368	\$1,368
		SWVL181845Q	18"	18"	49.98"	\$1,441	\$1,441
	Double Sided	SWWRR121845Q	18"	12"	49.98"	\$1,536	\$1,536
		SWWLL121845Q	18"	12"	49.98"	\$1,536	\$1,536
		SWWRL121845Q	18"	12"	49.98"	\$1,536	\$1,536
		SWWRR151845Q	18"	15"	49.98"	\$1,608	\$1,608
		SWWLL151845Q	18"	15"	49.98"	\$1,608	\$1,608
		SWWRL151845Q	18"	15"	49.98"	\$1,608	\$1,608
		SWWRR181845Q	18"	18"	49.98"	\$1,680	\$1,680
		SWWLL181845Q	18"	18"	49.98"	\$1,680	\$1,680
		SWWRL181845Q	18"	18"	49.98"	\$1,680	\$1,680
		SWWRR2445Q	18"	24"	49.98"	\$2049	N/A
		SWWLL2445Q	18"	24"	49.98"	\$2049	N/A
	SWWRL2445Q	18"	24"	49.98"	\$2049	N/A	
	Single Sided with pass thru capability	SWVR121845QP	18"	12"	49.98"	\$1,361	\$1,361
		SWVR151845QP	18"	15"	49.98"	\$1,436	\$1,436
		SWVR181845QP	18"	18"	49.98"	\$1,513	\$1,513
		SWVL121845QP	18"	12"	49.98"	\$1,361	\$1,361
		SWVL151845QP	18"	15"	49.98"	\$1,436	\$1,436
		SWVL181845QP	18"	18"	49.98"	\$1,513	\$1,513
	Double Sided with pass thru capability	SWWRR121845QP	18"	12"	49.98"	\$1,613	\$1,613
		SWWLL121845QP	18"	12"	49.98"	\$1,613	\$1,613
		SWWRL121845QP	18"	12"	49.98"	\$1,613	\$1,613
		SWWRR151845QP	18"	15"	49.98"	\$1,688	\$1,688
		SWWLL151845QP	18"	15"	49.98"	\$1,688	\$1,688
		SWWRL151845QP	18"	15"	49.98"	\$1,688	\$1,688
		SWWRR181845QP	18"	18"	49.98"	\$1,764	\$1,764
		SWWLL181845QP	18"	18"	49.98"	\$1,764	\$1,764
		SWWRL181845QP	18"	18"	49.98"	\$1,764	\$1,764
		SWWRR2445QP	18"	24"	49.98"	\$2211	N/A
		SWWLL2445QP	18"	24"	49.98"	\$2211	N/A
	SWWRL2445QP	18"	24"	49.98"	\$2211	N/A	



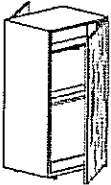

51" h Veneer Electrified Storage Wardrobe Cabinet

- Ganging hardware is included with wardrobe cabinet
- Matches overall height of 51"
- Pass thru capability creates a horizontal septum where jumper cables may "pass thru" the case
- No electrical or data access in wardrobe units
- Consult General Information on page D-4 for pull options

Description		Product No.	Depth	Width	Height	Weight lbs.	Coat Rod + Shelf
Veneer		SWWRR2445W	18"	24"	49.88"	90	\$2477
		SWWLL2445W	18"	24"	49.88"	90	\$2477
		SWWRL2445W	18"	24"	49.88"	90	\$2477
With Pass-Thru Capability		SWWRR2445WP	18"	24"	49.88"	90	\$2641
		SWWLL2445WP	18"	24"	49.88"	90	\$2641
		SWWRL2445WP	18"	24"	49.88"	90	\$2641



64" h 9900 Series Electrified Storage Wardrobe Cabinet

- Ganging hardware is included with wardrobe cabinet
- Matches overall height of 51"
- See General Pages for multiple shelf quantities
- Pass thru capability creates a horizontal septum where jumper cables may "pass thru" the case
- No electrical or data access in wardrobe units
- Consult General Information on page D-4 for pull options

Description	Product No.	Depth	Width	Height	Coat Rod +Shelf	Shelves
9900 Series						
 <p>Single Sided</p>	SWVR121858E	18"	12"	63.38"	\$1,080	\$1,080
	SWVR151858E	18"	15"	63.38"	\$1,140	\$1,140
	SWVR181858E	18"	18"	63.38"	\$1,201	\$1,201
	SWVL121858E	18"	12"	63.38"	\$1,080	\$1,080
	SWVL151858E	18"	15"	63.38"	\$1,140	\$1,140
	SWVL181858E	18"	18"	63.38"	\$1,201	\$1,201
 <p>Double Sided</p>	SWWRR121858E	18"	12"	63.38"	\$1,280	\$1,280
	SWWLL121858E	18"	12"	63.38"	\$1,280	\$1,280
	SWWRL121858E	18"	12"	63.38"	\$1,280	\$1,280
	SWWRR151858E	18"	15"	63.38"	\$1,340	\$1,340
	SWWLL151858E	18"	15"	63.38"	\$1,340	\$1,340
	SWWRL151858E	18"	15"	63.38"	\$1,340	\$1,340
	SWWRR181858E	18"	18"	63.38"	\$1,400	\$1,400
	SWWLL181858E	18"	18"	63.38"	\$1,400	\$1,400
	SWWRL181858E	18"	18"	63.38"	\$1,400	\$1,400
	SWWRR2458.5E	18"	24"	63.38"	\$1817	N/A
	SWWLL2458.5E	18"	24"	63.38"	\$1817	N/A
	SWWRL2458.5E	18"	24"	63.38"	\$1817	N/A
 <p>Single Sided with pass thru capability</p>	SWVR121845EP	18"	12"	63.38"	\$1,199	\$1,199
	SWVR151845EP	18"	15"	63.38"	\$1,267	\$1,267
	SWVR181845EP	18"	18"	63.38"	\$1,303	\$1,303
	SWVL121845EP	18"	12"	63.38"	\$1,199	\$1,199
	SWVL151845EP	18"	15"	63.38"	\$1,267	\$1,267
	SWVL181845EP	18"	18"	63.38"	\$1,303	\$1,303
 <p>Double Sided with pass thru capability</p>	SWWRR121845EP	18"	12"	63.38"	\$1,399	\$1,399
	SWWLL121845EP	18"	12"	63.38"	\$1,399	\$1,399
	SWWRL121845EP	18"	12"	63.38"	\$1,399	\$1,399
	SWWRR151845EP	18"	15"	63.38"	\$1,467	\$1,467
	SWWLL151845EP	18"	15"	63.38"	\$1,467	\$1,467
	SWWRL151845EP	18"	15"	63.38"	\$1,467	\$1,467
	SWWRR181845EP	18"	18"	63.38"	\$1,503	\$1,503
	SWWLL181845EP	18"	18"	63.38"	\$1,503	\$1,503
	SWWRL181845EP	18"	18"	63.38"	\$1,503	\$1,503
	SWWRR2458.5EP	18"	24"	63.38"	\$1980	N/A
	SWWLL2458.5EP	18"	24"	63.38"	\$1980	N/A
	SWWRL2458.5EP	18"	24"	63.38"	\$1980	N/A

64"h Nuform Electrified Storage Wardrobe Cabinet

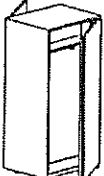
- Ganging hardware is included with wardrobe cabinet
- Matches overall height of 51"
- See General Pages for multiple shelf quantities
- Pass thru capability creates a horizontal septum where jumper cables may "pass thru" the case
- No electrical or data access in wardrobe units
- Consult General Information on page D-4 for pull options
- Nuform includes options of Solid or Woodgrain

Description	Product No.	Depth	Width	Height	Coat Rod +Shelf	Shelves	
Nuform							
	Single Sided	SWVR121858Q	18"	12"	63.38"	\$1,080	\$1,080
		SWVR151858Q	18"	15"	63.38"	\$1,140	\$1,140
		SWVR181858Q	18"	18"	63.38"	\$1,201	\$1,201
		SWVL121858Q	18"	12"	63.38"	\$1,080	\$1,080
		SWVL151858Q	18"	15"	63.38"	\$1,140	\$1,140
		SWVL181858Q	18"	18"	63.38"	\$1,201	\$1,201
	Double Sided	SWWRR121858Q	18"	12"	63.38"	\$1,679	\$1,679
		SWWLL121858Q	18"	12"	63.38"	\$1,679	\$1,679
		SWWRL121858Q	18"	12"	63.38"	\$1,679	\$1,679
		SWWRR151858Q	18"	15"	63.38"	\$1,760	\$1,760
		SWWLL151858Q	18"	15"	63.38"	\$1,760	\$1,760
		SWWRL151858Q	18"	15"	63.38"	\$1,760	\$1,760
		SWWRR181858Q	18"	18"	63.38"	\$1,804	\$1,804
		SWWLL181858Q	18"	18"	63.38"	\$1,804	\$1,804
		SWWRL181858Q	18"	18"	63.38"	\$1,804	\$1,804
		SWWRR2458.5Q	18"	24"	63.38"	\$2289	N/A
		SWWLL2458.5Q	18"	24"	63.38"	\$2289	N/A
	SWWRL2458.5Q	18"	24"	63.38"	\$2289	N/A	
	Single Sided with pass thru capability	SWVR121858QP	18"	12"	63.38"	\$1,199	\$1,199
		SWVR151858QP	18"	15"	63.38"	\$1,267	\$1,267
		SWVR181858QP	18"	18"	63.38"	\$1,303	\$1,303
		SWVL121858QP	18"	12"	63.38"	\$1,199	\$1,199
		SWVL151858QP	18"	15"	63.38"	\$1,267	\$1,267
		SWVL181858QP	18"	18"	63.38"	\$1,303	\$1,303
	Double Sided with pass thru capability	SWWRR121858QP	18"	12"	63.38"	\$1,763	\$1,763
		SWWLL121858QP	18"	12"	63.38"	\$1,763	\$1,763
		SWWRL121858QP	18"	12"	63.38"	\$1,763	\$1,763
		SWWRR151858QP	18"	15"	63.38"	\$1,848	\$1,848
		SWWLL151858QP	18"	15"	63.38"	\$1,848	\$1,848
		SWWRL151858QP	18"	15"	63.38"	\$1,848	\$1,848
		SWWRR181858QP	18"	18"	63.38"	\$1,894	\$1,894
		SWWLL181858QP	18"	18"	63.38"	\$1,894	\$1,894
		SWWRL181858QP	18"	18"	63.38"	\$1,894	\$1,894
		SWWRR2458.5EP	18"	24"	63.38"	\$2459	N/A
		SWWLL2458.5EP	18"	24"	63.38"	\$2452	N/A
	SWWRL2458.5EP	18"	24"	63.38"	\$2452	N/A	

64”h Electrified Storage Wardrobe Cabinet

- Ganging hardware is included with wardrobe cabinet
- Matches overall height of 64”
- Pass thru capability creates a horizontal septum where jumper cables may “pass thru” the case
- No electrical or data access in wardrobe units
- Consult General Information on page D-4 for pull options

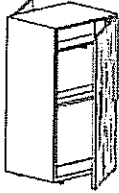
Description	Product No.	Depth	Width	Height	Coat Rod +Shelf
Veneer  With Pass-Thru Capability	SWWRR2458.5W	18”	24	63.38”	\$2711
	SWWLL2458.5W	18”	24	63.38”	\$2711
	SWWRL2458.5W	18”	24	63.38”	\$2711
	SWWRR2458.5WP	18”	24	63.38”	\$2874
	SWWRR2458.5WP	18”	24	63.38”	\$2874
	SWWRR2458.5WP	18”	24	63.38”	\$2874

9900 Series Wardrobe Tower

- Option of mitten shelf with coat rod or shelves

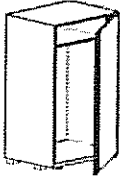
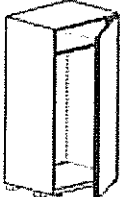
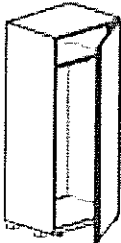
Description	Product No.	Depth	Width	List Price Rnd Glide		List Price Rect Glide		
				Coat Rod + Shelf	Shelves	Coat Rod + Shelf	Shelves	
Wardrobe Tower to match 44" h panel								
	INVR121839E-HD	18	12	\$999	\$999	\$1023	\$1023	
	INVR122439E-HD	24	12	\$1077	\$1077	\$1101	\$1101	
	INVR151839E-HD	18	15	\$1077	\$1077	\$1101	\$1101	
	INVR152439E-HD	24	15	\$1107	\$1107	\$1131	\$1131	
	INVR181839E-HD	18	18	\$1107	\$1107	\$1131	\$1131	
	INVR182439E-HD	24	18	\$1119	\$1119	\$1143	\$1143	
	INVL121839E-HD	18	12	\$999	\$999	\$1023	\$1023	
	INVL122439E-HD	24	12	\$1077	\$1077	\$1101	\$1101	
	INVL151839E-HD	18	15	\$1077	\$1077	\$1101	\$1101	
	INVL152439E-HD	24	15	\$1107	\$1107	\$1131	\$1131	
	INVL181839E-HD	18	18	\$1107	\$1107	\$1131	\$1131	
	INVL182439E-HD	24	18	\$1119	\$1119	\$1143	\$1143	
	Wardrobe Tower to match 51" h panel							
		INVR121846E-HD	18	12	\$1080	\$1080	\$1104	\$1104
INVR122446E-HD		24	12	\$1140	\$1140	\$1164	\$1164	
INVR151846E-HD		18	15	\$1140	\$1140	\$1164	\$1164	
INVR152446E-HD		24	15	\$1202	\$1202	\$1226	\$1226	
INVR181846E-HD		18	18	\$1202	\$1202	\$1226	\$1226	
INVR182446E-HD		24	18	\$1267	\$1267	\$1291	\$1291	
INVL121846E-HD		18	12	\$1080	\$1080	\$1104	\$1104	
INVL122446E-HD		24	12	\$1140	\$1140	\$1164	\$1164	
INVL151846E-HD		18	15	\$1140	\$1140	\$1164	\$1164	
INVL152446E-HD		24	15	\$1202	\$1202	\$1226	\$1226	
INVL181846E-HD		18	18	\$1202	\$1202	\$1226	\$1226	
INVL182446E-HD		24	18	\$1267	\$1267	\$1291	\$1291	
Wardrobe Tower to match 57" h panel								
		INVR121852E-HD	18	12	\$1175	\$1175	\$1199	\$1199
	INVR122452E-HD	24	12	\$1215	\$1215	\$1239	\$1239	
	INVR151852E-HD	18	15	\$1215	\$1215	\$1239	\$1239	
	INVR152452E-HD	24	15	\$1257	\$1257	\$1281	\$1281	
	INVR181852E-HD	18	18	\$1257	\$1257	\$1281	\$1281	
	INVR182452E-HD	24	18	\$1299	\$1299	\$1323	\$1323	
	INVL121852E-HD	18	12	\$1175	\$1175	\$1199	\$1199	
	INVL122452E-HD	24	12	\$1215	\$1215	\$1239	\$1239	
	INVL151852E-HD	18	15	\$1215	\$1215	\$1239	\$1239	
	INVL152452E-HD	24	15	\$1257	\$1257	\$1281	\$1281	
	INVL181852E-HD	18	18	\$1257	\$1257	\$1281	\$1281	
	INVL182452E-HD	24	18	\$1299	\$1299	\$1323	\$1323	

9900 Series Wardrobe Tower

- Option of mitten shelf with coat rod or shelves
- includes flat glide

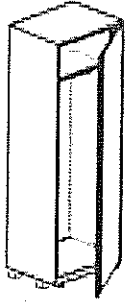
Description	Product No.	Depth	Width	List Price Rnd Glide		List Price Rect Glide	
				Coat Rod + Shelf	Shelves	Coat Rod + Shelf	Shelves
Wardrobe Tower to match 64" h panel 	INVR121860E-HD	18"	12"	\$1,199	\$1,199	\$1223	\$1223
	INVR122460E-HD	24"	12"	\$1,267	\$1,267	\$1291	\$1291
	INVR151860E-HD	18"	15"	\$1,267	\$1,267	\$1291	\$1291
	INVR152460E-HD	24"	15"	\$1,303	\$1,303	\$1327	\$1327
	INVR181860E-HD	18"	18"	\$1,303	\$1,303	\$1327	\$1327
	INVR182460E-HD	24"	18"	\$1,340	\$1,340	\$1364	\$1364
	INVL121860E-HD	18"	12"	\$1,199	\$1,199	\$1223	\$1223
	INVL122460E-HD	24"	12"	\$1,267	\$1,267	\$1291	\$1291
	INVL151860E-HD	18"	15"	\$1,267	\$1,267	\$1291	\$1291
	INVL152460E-HD	24"	15"	\$1,303	\$1,303	\$1327	\$1327
	INVL181860E-HD	18"	18"	\$1,303	\$1,303	\$1327	\$1327
	INVL182460E-HD	24"	18"	\$1,340	\$1,340	\$1364	\$1364

9900 Series Towers

- towers match 64" h panel

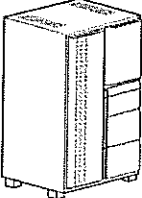
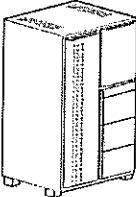
Description	Product No.	Depth	Width	List Price Rect Guide
24" h Hinged door insert/1-3", 1-7.5" and 2-12" drawers				
	GETL2458-PB7FF	24"	24"	\$2868
	GETR2458-PB7FF	24"	24"	\$2868
	GETL3058-PB7FF	24"	30"	\$3281
	GETR3058-PB7FF	24"	30"	\$3281
24" h Hinged door insert/3", 3-10.5"				
	GETL2458-P3F10	24"	24"	\$2868
	GETR2458-P3F10	24"	24"	\$2868
	GETL3058-P3F10	24"	30"	\$3281
	GETR3058-P3F10	24"	30"	\$3281

MODESTY PANELS

Modesty Panels

- Modesty panels are available in a variety of materials and mounting options correspond with each variety.
- Modesty panels mount to the underside of a 1" or 1 ¼" thick worksurface and are field installed.
- See Application Guide for specific dimension detailed applications

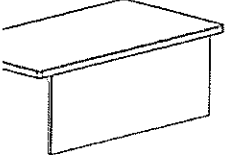
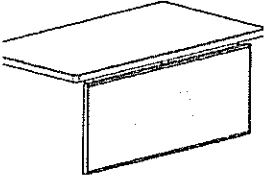
Description	Product No.	Height	Width	Weight lbs.	Paint		
Painted Partial Height Modesty Panel							
	INMDPNP30	13.5"	30"				\$103
	INMDPNP33	13.5"	33"				\$106
	INMDPNP36	13.5"	36"				\$108
	INMDPNP39	13.5"	39"				\$110
	INMDPNP42	13.5"	42"				\$113
	INMDPNP45	13.5"	45"				\$116
	INMDPNP48	13.5"	48"				\$119
	INMDPNP51	13.5"	51"				\$121
	INMDPNP54	13.5"	54"				\$123
	INMDPNP57	13.5"	57"				\$126
	INMDPNP60	13.5"	60"				\$128
	INMDPNP63	13.5"	63"				\$130
	INMDPNP66	13.5"	66"				\$132
	INMDPNP69	13.5"	69"				\$133
INMDPNP72	13.5"	72"				\$135	
<hr/>							
Wood Partial Height Modesty Panel					Nuform	Laminate	Veneer
	INMDPNW30	13.5"	30"		\$238	\$238	\$354
	INMDPNW33	13.5"	33"		\$255	\$255	\$372
	INMDPNW36	13.5"	36"		\$261	\$261	\$390
	INMDPNW39	13.5"	39"		\$293	\$293	\$408
	INMDPNW42	13.5"	42"		\$299	\$299	\$427
	INMDPNW45	13.5"	45"		\$305	\$305	\$445
	INMDPNW48	13.5"	48"		\$311	\$311	\$470
	INMDPNW51	13.5"	51"		\$342	\$342	\$488
	INMDPNW54	13.5"	54"		\$348	\$348	\$513
	INMDPNW57	13.5"	57"		\$354	\$354	\$531
	INMDPNW60	13.5"	60"		\$372	\$372	\$549
	INMDPNW63	13.5"	63"		\$435	\$435	\$567
	INMDPNW66	13.5"	66"		\$453	\$453	\$585
	INMDPNW69	13.5"	69"		\$471	\$471	\$604
	INMDPNW72	13.5"	72"		\$489	\$489	\$628
	INMDPNW75	13.5"	75"		\$545	\$545	\$646
	INMDPNW78	13.5"	78"		\$549	\$549	\$665
INMDPNW81	13.5"	81"		\$554	\$554	\$683	
INMDPNW84	13.5"	84"		\$558	\$558	\$701	
INMDPNW87	13.5"	87"		\$563	\$563	\$719	
INMDPNW90	13.5"	90"		\$567	\$567	\$737	

Modesty Panels

- Modesty panels are available in a variety of materials and mounting options correspond with each variety.
- Modesty panels mount to the underside of a 1" or 1 1/4" thick worksurface and are field installed.
- See Application Guide for specific dimension detailed applications

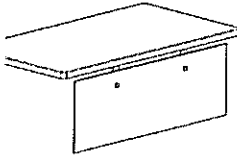
Description	Product No.	Height	Width	Weight lbs.	White Acrylic
Acrylic Partial Height Modesty Panel					
	INMDPNA30	13.5"	30"		\$392
	INMDPNA33	13.5"	33"		\$396
	INMDPNA36	13.5"	36"		\$401
	INMDPNA39	13.5"	39"		\$406
	INMDPNA42	13.5"	42"		\$412
	INMDPNA45	13.5"	45"		\$419
	INMDPNA48	13.5"	48"		\$424
	INMDPNA51	13.5"	51"		\$443
	INMDPNA54	13.5"	54"		\$462
	INMDPNA57	13.5"	57"		\$480
	INMDPNA60	13.5"	60"		\$504
	INMDPNA63	13.5"	63"		\$528
	INMDPNA66	13.5"	66"		\$552
	INMDPNA69	13.5"	69"		\$576
	INMDPNA72	13.5"	72"		\$600
	INMDPNA75	13.5"	75"		\$613
	INMDPNA78	13.5"	78"		\$627
	INMDPNA81	13.5"	81"		\$640
INMDPNA84	13.5"	84"		\$653	
INMDPNA87	13.5"	87"		\$667	
INMDPNA90	13.5"	90"		\$681	

Frame Frosted Acrylic Partial Height Modesty Panel

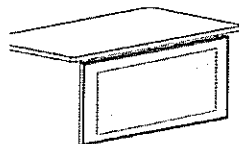

					Frosted Acrylic
INMDPNG30	13.5"	30"			\$588
INMDPNG33	13.5"	33"			\$608
INMDPNG36	13.5"	36"			\$627
INMDPNG39	13.5"	39"			\$646
INMDPNG42	13.5"	42"			\$665
INMDPNG45	13.5"	45"			\$685
INMDPNG48	13.5"	48"			\$704
INMDPNG51	13.5"	51"			\$723
INMDPNG54	13.5"	54"			\$742
INMDPNG57	13.5"	57"			\$762
INMDPNG60	13.5"	60"			\$781
INMDPNG63	13.5"	63"			\$911
INMDPNG66	13.5"	66"			\$930
INMDPNG69	13.5"	69"			\$950
INMDPNG72	13.5"	72"			\$969
INMDPNG75	13.5"	75"			\$988
INMDPNG78	13.5"	78"			\$1,007
INMDPNG81	13.5"	81"			\$1,027
INMDPNG84	13.5"	84"			\$1,046
INMDPNG87	13.5"	87"			\$1,066
INMDPNG90	13.5"	90"			\$1,085

Modesty Panels

- Modesty panels are available in a variety of materials and mounting options correspond with each variety.
- Modesty panels mount to the underside of a 1" or 1 ¼" thick worksurface and are field installed.
- See Application Guide for specific dimension detailed applications

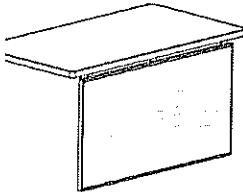
Description	Product No.	Height	Width	Weight lbs.	Nuform	Laminate	Veneer
Wood Full Height Modesty Panel							
	INMDFHPNW30	24"	30"		\$307	\$307	\$505
	INMDFHPNW33	24"	33"		\$335	\$335	\$538
	INMDFHPNW36	24"	36"		\$343	\$343	\$571
	INMDFHPNW39	24"	39"		\$391	\$391	\$604
	INMDFHPNW42	24"	42"		\$399	\$399	\$637
	INMDFHPNW45	24"	45"		\$356	\$356	\$671
	INMDFHPNW48	24"	48"		\$415	\$415	\$711
	INMDFHPNW51	24"	51"		\$514	\$514	\$744
	INMDFHPNW54	24"	54"		\$522	\$522	\$784
	INMDFHPNW57	24"	57"		\$530	\$530	\$817
	INMDFHPNW60	24"	60"		\$544	\$544	\$850
	INMDFHPNW63	24"	63"		\$567	\$567	\$883
	INMDFHPNW66	24"	66"		\$583	\$583	\$916
	INMDFHPNW69	24"	69"		\$597	\$597	\$949
	INMDFHPNW72	24"	72"		\$610	\$610	\$989
	INMDFHPNW75	24"	75"		\$696	\$696	\$1,022
	INMDFHPNW78	24"	78"		\$702	\$702	\$1,055
	INMDFHPNW81	24"	81"		\$707	\$707	\$1,089
	INMDFHPNW84	24"	84"		\$712	\$712	\$1,122
INMDFHPNW87	24"	87"		\$716	\$716	\$1,155	
INMDFHPNW90	24"	90"		\$722	\$722	\$1,188	

Frame Frosted Acrylic Glass Full Height Modesty Panel

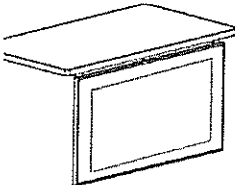
Description	Product No.	Height	Width	Weight lbs.	Nuform	Laminate	Veneer	Frosted Acrylic
	INMDFHPNG30	24"	30"					\$702
	INMDFHPNG33	24"	33"					\$729
	INMDFHPNG36	24"	36"					\$757
	INMDFHPNG39	24"	39"					\$785
	INMDFHPNG42	24"	42"					\$813
	INMDFHPNG45	24"	45"					\$840
	INMDFHPNG48	24"	48"					\$868
	INMDFHPNG51	24"	51"					\$896
	INMDFHPNG54	24"	54"					\$923
	INMDFHPNG57	24"	57"					\$951
	INMDFHPNG60	24"	60"					\$979
	INMDFHPNG63	24"	63"					\$1,117
	INMDFHPNG66	24"	66"					\$1,145
	INMDFHPNG69	24"	69"					\$1,173
	INMDFHPNG72	24"	72"					\$1,201
	INMDFHPNG75	24"	75"					\$1,228
	INMDFHPNG78	24"	78"					\$1,256
	INMDFHPNG81	24"	81"					\$1,284
	INMDFHPNG84	24"	84"					\$1,311
INMDFHPNG87	24"	87"					\$1,339	
INMDFHPNG90	24"	90"					\$1,365	